

# **Power Panel C30**

## **User's manual**

Version: **1.10 (September 2018)**  
Model no.: **MAPPC30-ENG**

### **Translation of the original documentation**

All values in this manual are current as of its publication. We reserve the right to change the contents of this manual without notice. B&R Industrial Automation GmbH is not liable for technical/editorial errors or incomplete information in this manual. In addition, B&R Industrial Automation GmbH shall not be liable for incidental or consequential damages in connection with or arising from the furnishing, performance or use of this material. We point out that the software and hardware names and brand names of the respective companies used in this document are subject to general trademark, brand or patent protection.



<b>1 General information.....</b>	<b>5</b>
1.1 Manual history.....	5
1.2 Safety guidelines.....	6
1.2.1 Introduction.....	6
1.2.2 Intended use.....	6
1.2.3 Protection against electrostatic discharge.....	6
1.2.3.1 Packaging.....	6
1.2.3.2 Guidelines for proper ESD handling.....	6
1.2.4 Policies and procedures.....	7
1.2.5 Transport and storage.....	7
1.2.6 Installation.....	7
1.2.7 Operation.....	8
1.2.7.1 Protection against touching electrical parts.....	8
1.2.7.2 Environmental conditions - Dust, moisture, corrosive gases.....	8
1.2.7.3 Viruses and dangerous programs.....	8
1.2.8 Environmentally friendly disposal.....	8
1.2.8.1 Separation of materials.....	8
1.2.9 Organization of notices.....	9
1.2.10 Safety-relevant symbols.....	9
<b>2 System characteristics.....</b>	<b>10</b>
2.1 Compact solution.....	10
2.2 Simple programming.....	10
2.3 Efficient.....	11
2.4 Flexibility.....	11
2.5 Model number key.....	12
<b>3 Device description.....</b>	<b>13</b>
3.1 Type overview.....	13
3.2 General technical data.....	13
3.2.1 Data and real-time clock buffering.....	13
3.2.2 Viewing angles.....	14
3.2.3 Surface resistance of the panel overlay.....	14
3.2.4 Surface resistance of the touch screen.....	15
3.3 Power Panel C30 - 4.3" variants.....	16
3.3.1 Order data.....	16
3.3.2 Technical data.....	16
3.3.3 Dimensions.....	19
3.4 Power Panel C30 - 7.0" variants.....	20
3.4.1 Order data.....	20
3.4.2 Technical data.....	20
3.4.3 Dimensions.....	23
3.5 Power Panel C30 - 10.1" variants.....	24
3.5.1 Order data.....	24
3.5.2 Technical data.....	24
3.5.3 Dimensions.....	27
3.6 Diagnostic LEDs.....	28
3.7 Reset button / Operating modes.....	29
3.8 Connection elements.....	30
3.8.1 Fieldbus interfaces.....	30
3.8.1.1 2x CAN bus interface.....	31
3.8.1.2 1x CAN bus and 1x RS232 interface.....	31
3.8.1.3 1x CAN bus and 1x RS485 interface.....	32
3.8.2 Ethernet interface.....	32
3.8.3 USB interfaces.....	33
3.8.4 Power supply.....	33

<b>4 Commissioning.....</b>	<b>35</b>
4.1 Installation.....	35
4.1.1 Requirements for the cables used.....	35
4.1.2 Installation cutout requirements.....	36
4.1.3 Mounting with retaining clips.....	36
4.1.4 Installation instructions.....	37
4.1.5 Mounting orientations.....	39
4.1.6 Grounding.....	40
4.2 Commissioning.....	42
4.3 Operating the Power Panel.....	43
4.3.1 Touch screen.....	43
4.3.2 Touch screen calibration.....	44
4.3.3 Set brightness with the application.....	44
4.3.4 Screen rotation.....	44
<b>5 Maintenance.....</b>	<b>45</b>
5.1 Cleaning.....	45
5.2 User tips for increasing the service life of the display or touch screen.....	46
5.2.1 Service life.....	46
5.2.2 Backlight.....	46
5.2.3 Image persistence.....	46
<b>6 Accessories.....</b>	<b>48</b>
6.1 Overview.....	48
6.2 TB6102 2-pin power supply connector.....	49
6.2.1 Order data.....	49
6.2.2 Technical data.....	49
6.3 OTB5106.2110-01 6-pin cage clamp terminal block.....	50
6.3.1 Order data.....	50
6.3.2 Technical data.....	50
6.4 Data storage devices.....	50
<b>7 International and national certifications.....</b>	<b>51</b>
7.1 Overview of certifications.....	51
7.2 EU directives and standards (CE).....	52
7.2.1 Overview of standards.....	53
7.2.2 Requirements for immunity to disturbances.....	54
7.2.3 Emission requirements.....	56
7.2.4 Mechanical conditions.....	57
7.2.5 Electrical safety.....	58
7.3 Underwriters Laboratories (UL).....	58

# 1 General information

## Information:

B&R makes every effort to keep user's manuals as current as possible. The most current versions can be downloaded from the B&R website [www.br-automation.com](http://www.br-automation.com).

## 1.1 Manual history

Version	Date	Comment
1.10	September 2018	New content: <ul style="list-style-type: none"> <li>• New interface variants: 1x CAN bus and 1x RS485, 1x CAN bust and 1x RS232</li> <li>• New display variant: 10.1"</li> </ul> Content-related corrections: <ul style="list-style-type: none"> <li>• Documentation of CAN terminating resistor and AR 4.26 (see note in section "Fieldbus interfaces" on page 30).</li> </ul>
1.04	October 2017	Content-related corrections: <ul style="list-style-type: none"> <li>• Revised installation note.</li> <li>• Revised graphics.</li> </ul> Editorial changes.
1.03	October 2017	Updated technical data.
1.02	January 2017	Content-related corrections: <ul style="list-style-type: none"> <li>• Revised section "Viewing angle".</li> <li>• Corrected description of diagnostic LEDs.</li> <li>• Corrected danger warning regarding PELV power supply.</li> <li>• Added publishing information.</li> </ul> Editorial corrections.
1.01	October 2016	Content-related corrections: <ul style="list-style-type: none"> <li>• Technical data: Viewing angle, power consumption.</li> <li>• Switchable terminating resistors for CAN bus: Version dependency to Automation Studio and Automation Runtime.</li> <li>• Reformulated note regarding USB devices.</li> </ul> Editorial corrections: <ul style="list-style-type: none"> <li>• Minor change to manual structure.</li> <li>• Other corrections.</li> </ul>
1.00	August 2016	First edition

## 1.2 Safety guidelines

### Important!

If the device is used in a manner not specified by the manufacturer, the protection provided by the device may be impaired.

### 1.2.1 Introduction

Programmable logic controllers (PLCs), operating/monitoring devices (industrial PCs, Power Panels, Mobile Panels, etc.) and uninterruptible power supplies from B&R have been designed, developed and manufactured for conventional use in industrial environments. They were not designed, developed and manufactured for any use involving serious risks or hazards that could lead to death, injury, serious physical impairment or loss of any kind without the implementation of exceptionally stringent safety precautions. In particular, this includes the use of these devices to monitor nuclear reactions in nuclear power plants, in flight control or flight safety systems as well as in the control of mass transportation systems, medical life support systems or weapons systems.

When using programmable logic controllers or operating/monitoring devices as control systems in connection with a Soft PLC (e.g. Automation Runtime or comparable product) or Slot PLC (e.g. B&R LS251 or comparable product), safety precautions relevant to industrial control systems (e.g. the provision of safety devices such as emergency stop, etc.) must be observed in accordance with applicable national and international regulations. This also applies to all other devices connected to the system, such as drives.

All tasks such as the installation, commissioning and servicing of devices are only permitted to be carried out by qualified personnel. Qualified personnel are those familiar with the transport, mounting, installation, commissioning and operation of devices who also have the appropriate qualifications to perform these tasks (e.g. IEC 60364). National accident prevention regulations must be observed.

The safety notices, information about connection conditions (nameplate and documentation) and limit values specified in the technical data must be read carefully before installation and commissioning and are to be observed in all cases.

### 1.2.2 Intended use

Electronic devices are never completely failsafe. If the programmable logic controller, operating/monitoring device or uninterruptible power supply fails, the user is responsible for ensuring that other connected devices such as motors are brought to a safe state.

### 1.2.3 Protection against electrostatic discharge

Electrical components that can be damaged by electrostatic discharge (ESD) must be handled accordingly.

#### 1.2.3.1 Packaging

- Electrical components with a housing  
...do not require special ESD packaging but must be handled properly (see "[Electrical components with a housing](#)" on page 6).
- Electrical components without a housing  
...are protected by ESD-suitable packaging.

#### 1.2.3.2 Guidelines for proper ESD handling

##### Electrical components with a housing

- Do not touch the connector contacts on the device (bus data contacts).
- Do not touch the connector contacts on connected cables.
- Do not touch the contact tips on circuit boards.

## Electrical components without a housing

The following points apply in addition to the points listed under "Electrical components with a housing":

- Any persons handling electrical components or devices with installed electrical components must be grounded.
- Components are only permitted to be touched on their narrow sides or front plate.
- Components must always be placed on or stored in a suitable medium (ESD packaging, conductive foam, etc.).

### **Information: Metallic surfaces are not suitable storage surfaces!**

- Components must not be subjected to electrostatic discharge (e.g. caused by charged plastics).
- Observe a minimum distance of 10 cm from monitors and television sets.
- Measuring instruments and equipment must be grounded.
- Probe tips of galvanically isolated measuring instruments must be temporarily discharged on suitably grounded surfaces before taking measurements.

## Individual components

- ESD protective measures for individual components are thoroughly implemented at B&R (conductive floors, footwear, arm bands, etc.).
- Increased ESD protective measures for individual components are not required for handling B&R products at customer locations.

### 1.2.4 Policies and procedures

Electronic devices are never completely failsafe. If the programmable logic controller, operating/monitoring device or uninterruptible power supply fails, the user is responsible for ensuring that other connected devices such as motors are brought to a safe state.

When using programmable logic controllers or operating/monitoring devices as control systems in connection with a Soft PLC (e.g. B&R Automation Runtime or comparable product) or Slot PLC (e.g. B&R LS251 or comparable product), safety precautions relevant to industrial control systems (e.g. the provision of safety devices such as emergency stop, etc.) must be observed in accordance with applicable national and international regulations. This also applies to all other devices connected to the system, such as drives.

All tasks such as the installation, commissioning and servicing of devices are only permitted to be carried out by qualified personnel. Qualified personnel are those familiar with the transport, mounting, installation, commissioning and operation of devices who also have the appropriate qualifications to perform these tasks (e.g. IEC 60364). National accident prevention regulations must be observed.

The safety notices, information about connection conditions (nameplate and documentation) and limit values specified in the technical data must be read carefully before installation and commissioning and are to be observed in all cases.

### 1.2.5 Transport and storage

During transport and storage, devices must be protected against undue stress (mechanical loads, temperature, moisture, corrosive atmospheres, etc.).

Devices contain components sensitive to electrostatic charges that can be damaged by improper handling. It is therefore necessary to provide the required protective measures against electrostatic discharge when installing or removing these devices (see "[Protection against electrostatic discharge](#)" on page 6).

### 1.2.6 Installation

- Installation must be performed according to this documentation using suitable equipment and tools.
- Devices are only permitted to be installed by qualified personnel and when the power is switched off.
- General safety guidelines and national accident prevention regulations must be observed.
- Electrical installation must be carried out in accordance with applicable guidelines (e.g. wire cross sections, fuses, protective ground connections).
- Take the necessary protective measures against electrostatic discharge (see "[Protection against electrostatic discharge](#)" on page 6).

## 1.2.7 Operation

### 1.2.7.1 Protection against touching electrical parts

To operate programmable logic controllers, operating/monitoring devices and uninterruptible power supplies, certain components must carry dangerous voltage levels over 42 VDC. Touching one of these components can result in a life-threatening electric shock. This could lead to death, severe injury or damage to property.

Before switching on programmable logic controllers, operating/monitoring devices or the uninterruptible power supply, it must be ensured that the housing is properly connected to ground (PE rail). Ground connections must also be established when the operating/monitoring device or uninterruptible power supply is connected for test purposes or only being operated for a short period of time!

Before switching on the device, all voltage-carrying components must be securely covered. During operation, all covers must remain closed.

### 1.2.7.2 Environmental conditions - Dust, moisture, corrosive gases

The use of operating/monitoring devices (e.g. industrial PCs, Power Panels, Mobile Panels) and uninterruptible power supplies in very dusty environments must be avoided. The collection of dust on devices can affect functionality and may prevent sufficient cooling, especially in systems with active cooling (fans).

The presence of corrosive gases can also result in impaired functionality. In combination with high temperature and humidity, corrosive gases – e.g. with sulfur, nitrogen and chlorine components – can induce chemical reactions that can damage electronic components very quickly. The presence of corrosive gases is indicated by blackened copper surfaces and cable ends on existing installations.

When operated in dusty or moist environments that could potentially impair functionality, operating/monitoring devices such as the Automation Panel and Power Panel are protected on the front against the ingress of dust or moisture when installed properly (e.g. cutout installation). The back of all devices must be protected from the ingress of dust and moisture, however; any collected dust must be removed at suitable intervals.

### 1.2.7.3 Viruses and dangerous programs

This system is subject to potential risk each time data is exchanged or software is installed from a data storage medium (e.g. diskette, CD-ROM, USB flash drive, etc.), network connection or the Internet. The user is responsible for assessing these risks, implementing preventive measures such as virus protection programs, firewalls, etc. and making sure that software is obtained only from trusted sources.

## 1.2.8 Environmentally friendly disposal

All programmable controllers, operating/monitoring devices and uninterruptible power supplies from B&R are designed to minimize harm to the environment as far as possible.

### 1.2.8.1 Separation of materials

It is necessary to separate out the different materials so that devices can undergo an environmentally friendly recycling process.

Component	Disposal
Programmable logic controllers Operating/Monitoring devices Uninterruptible power supply Batteries and rechargeable batteries Cables	Electronics recycling
Cardboard/Paper packaging	Paper/Cardboard recycling
Plastic packaging material	Plastic recycling

Table 1: Environmentally friendly disposal

Disposal must take place in accordance with applicable legal regulations.



## 1.2.9 Organization of notices

### Safety notices

Contain **only** information that warns of dangerous functions or situations.

Signal word	Description
<b>Danger!</b>	Failure to observe these safety guidelines and notices will result in death, severe injury or substantial damage to property.
<b>Warning!</b>	Failure to observe these safety guidelines and notices can result in death, severe injury or substantial damage to property.
<b>Caution!</b>	Failure to observe these safety guidelines and notices can result in minor injury or damage to property.
<b>Notice!</b>	Failure to observe these safety guidelines and notices can result in damage to property.

Table 2: Organization of safety notices

### General notices

Contain **useful** information for users and instructions for avoiding malfunctions.

Signal word	Description
<b>Information:</b>	Useful information, application tips and instructions for avoiding malfunctions.

Table 3: Organization of general notices

## 1.2.10 Safety-relevant symbols

The following symbols may appear on the unit or its packaging:

Symbol	Explanation
	<p>The operating instructions must be observed.</p> <p>This documentation contains information about types of potential hazards and enables you to identify risks and implement countermeasures.</p>

## 2 System characteristics

---

The Power Panel C30 is available in display variants from 4.3" to 10.1" and equipped with 1x Ethernet, 2x USB and 2x fieldbus interfaces.



### 2.1 Compact solution

With an extremely compact design, minimal installation depth and intelligent cable outlet arrangement, Power Panels are extreme space-savers that are very easy to install. They also have no hard disks, fans or batteries, which makes them maintenance-free. The front of the panel provides IP65 protection, making these devices extremely well-suited for harsh industrial environments.

### 2.2 Simple programming

The complete integration of the HMI application in the Automation Studio development environment goes without saying. The same is true for programming in all of the IEC languages offered by B&R as well as Automation Basic and ANSI C.

## 2.3 Efficient

The Power Panel C30 is an HMI terminal with a built-in PLC. The ARM Cortex-A8 provides enough performance to allow applications to achieve cycle times down to 1 ms. Automation Runtime, which provides up to eight task classes, is the basis for this.



## 2.4 Flexibility

The Power Panel C30 is available in multiple display sizes with various fieldbus interfaces.

- 4.3" variants
- 7.0" variants
- 10.1" variants
- 2x CAN bus
- 1x CAN bus, 1x RS232
- 1x CAN bus, 1x RS485

A touch button is integrated in the panel overlay at the lower right corner of the display. This element elegantly incorporated in the HMI application and makes it easy to switch between HMI pages or to a home or help function.

The Power Panel C30 is available in landscape and in an anthracite gray pinstripe design, and is characterized by a very shallow installation depth and minimized border width. At the same time, there were no compromises made with regard to stability or seal integrity.

## 2.5 Model number key

Product area															
4	Embedded PC-based automation														
Product family															
P	P	Power Panel													
Model															
C	Controller series														
Variant (processor power)															
3	0	ARM processor (Cortex-A8, single core)													
Diagonal															
.	0	4	3								4.3"				
.	0	7	0								7.0"				
.	1	0	1								10.1"				
Resolution															
2	WVGA (800 x 480) landscape														
F	WQVGA (480 x 272) landscape														
G	WSVGA (1024 x 600) landscape														
Display / Touch screen technology															
-	2	TFT color + analog resistive touch screen													
Optional interfaces and features															
1	2x CAN bus														
2	1x CAN bus and 1x RS232														
3	1x CAN bus and 1x RS485														
Front design															
Standard variants															
B	Anthracite gray pinstripe														
Industry-specific variant															
I	.	.	.	Seq. number: I[0...Z][0...Z][0...Z]											
Customized panel overlay only															
F	.	.	.	Seq. number: F[0...Z][0...Z][0...Z]											
Complete customized variant															
C	.	.	.	Seq. number: C[0...Z][0...Z][0...Z]											
Model or I/O variants															
											Base model				
										- 0 1	Derivative: Sequential number [0...Z]				
Examples															
4	P	P	C	3	0	.	0	4	3	F	-	2	1	B	Power Panel C30, 4.3", landscape format, fieldbus interfaces: 2x CAN bus. CPU and memory: 1 GHz (ARM Cortex-A8), 256 MB DDRAM, 8 kB FRAM, 512 MB onboard flash drive. Display and touch screen: 4.3", 480 x 272 (WQVGA) resolution, analog resistive touch screen, landscape format, anthracite gray pinstripe. Interfaces: 1x Ethernet 10/100 Mbit/s, 2x USB 2.0, 2x CAN bus.
4	P	P	C	3	0	.	0	7	0	2	-	2	1	B	Power Panel C30, 7.0", landscape format, fieldbus interfaces: 2x CAN bus. CPU and memory: 1 GHz (ARM Cortex-A8), 256 MB DDRAM, 8 kB FRAM, 512 MB onboard flash drive. Display and touch screen: 7.0", 800 x 480 (WVGA) resolution, analog resistive touch screen, landscape format, anthracite gray pinstripe. Interfaces: 1x Ethernet 10/100 Mbit/s, 2x USB 2.0, 2x CAN bus.

## 3 Device description

### 3.1 Type overview

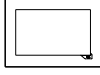
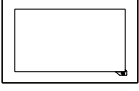
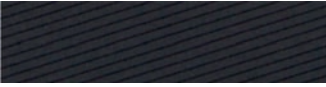
Panel size	4.3"	7.0"	10.1"
Format	Landscape format	Landscape format	Landscape
			
Model number	4PPC30.043F-2xB	4PPC30.0702-2xB	4PPC30.101G-2xB
Resolution	WQVGA (480 x 272)	WVGA (800 x 480)	WSVGA (1024 x 600)
Model number	4PPC30.043F-2xB	4PPC30.0702-2xB	4PPC30.070G-2xB
Panel overlay	Pinstripe pattern in anthracite		
			
Model number	4PPC30.xxxx-21B		
Interfaces	4PPC30.xxxx-2xB		
	1	2	3
IF1: USB	•	•	•
IF2: USB	•	•	•
IF3: Ethernet	•	•	•
IF4: CAN bus	•	•	•
IF5: RS485			•
IF6: CAN bus	•		
IF8: RS232		•	

### 3.2 General technical data

Name	Description
Processor	ARM Cortex-A8 1 GHz
Memory	256 MB DDR3 RAM
Interfaces	1x Ethernet interface 10BASE-T/100BASE-TX 2x USB 2.0 interfaces 2x fieldbus interface depending on the variant <ul style="list-style-type: none"> <li>• 2x CAN interface</li> <li>• 1x CAN interface, 1x RS232</li> <li>• 1x CAN interface, 1x RS485</li> </ul>
Other	<b>IP65 protection (front)</b> Temperature range from -20 to 60°C Fanless 24 VDC power supply -15% / +20%

#### 3.2.1 Data and real-time clock buffering

Power Panels are not designed for use with batteries. This makes them completely maintenance-free. The following features make operation without a backup battery possible.

Data and real-time clock buffering	Type of buffering	Note
Remanent variables	FRAM	This FRAM stores its contents ferroelectrically. Unlike normal SRAM, this does not require a battery.
Real-time clock	Gold foil capacitor	The real-time clock is buffered for approx. 1000 hours by a gold foil capacitor. The gold foil capacitor is completely charged after 3 continuous hours of operation.

### 3.2.2 Viewing angles

For the viewing angles values (U, D, R, L) of the display types, see the technical data of the respective device.

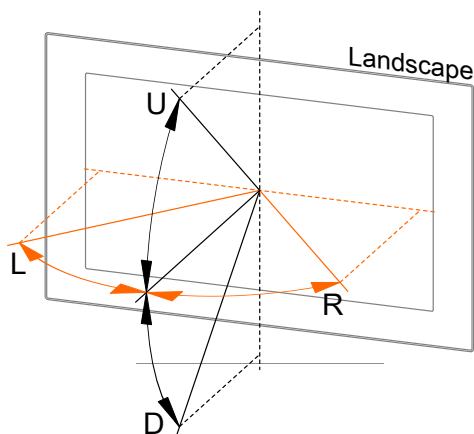

Legend:	Display viewing angle
U	From top
D	From bottom
L	From left
R	From right

The viewing angles are specified for the horizontal (L, R) and vertical (U, D) axes in reference to the vertical axis of the display. The specified viewing angles above always refer to the standard mounting orientation of the respective Power Panel.

Standard mounting orientation: The Hand button is at the bottom right.

### 3.2.3 Surface resistance of the panel overlay

The panel overlay conforms to DIN 42115 (Part 2). This means it is resistant to exposure to the following chemicals for a 24-hour period with no visible signs of damage:

Ethanol Cyclohexanol Diacetone alcohol Glycol Isopropanol Glycerine Methanol Triacetin Dowandol DRM/PM	Formaldehyde 37%-42% Acetaldehyde Aliphatic hydrocarbons Toluene Xylene White spirits	Trichloroethane Ethyl acetate Diethyl ether n-Butyl acetate Amyl acetate Butylcellosolve Ether
Acetone Methyl ethyl ketone Dioxan Cyclohexanone Methylisobutylketone (MIBK) Isophorone	Formic acid <50% Acetic acid <50% Phosphoric acid <30% Hydrochloric acid <36% Nitric acid <10% Trichloroacetic acid <50% Sulphuric acid <10%	Sodium chloride <20% Hydrogen peroxide <25% Potassium carbonate Washing agents Tenside Fabric conditioner Iron (II) chloride Iron (III) chloride Dibutyl phthalate Diocetyl phthalate Sodium carbonate
Ammonia <40% Caustic soda <40% Potassium hydroxide Alkali carbonate Bichromate Potassium ferro cyanide Acetonitrile Sodium bisulphate	Cutting oil Diesel oil Linseed oil Paraffin oil Ricinus oil Silicon oil Turpentine oil substitute Brake fluid Aviation fuel Gasoline Water Sea water Decon	

## Information:

The specified characteristics, features and limit values only apply to this individual component and can deviate from those specified for the complete system.

The panel overlay is resistant to exposure to glacial acetic acid for less than one hour without visible damage per DIN 42115 Part 2.

### 3.2.4 Surface resistance of the touch screen

The surface of the analog resistive touch screen is resistant to the following chemicals at a temperature of 25°C for a duration of 1 hour.

- Acetone
- Methylene chloride
- Butanone
- Isopropyl alcohol
- Hexane
- Turpentine
- Mineral spirit
- Unleaded gasoline
- Diesel fuel
- Motor oil
- Transmission fluid
- Antifreeze
- Ammonia-based glass cleaner
- Washing agents
- Household cleaners
- Vinegar
- Coffee
- Tea
- Lubricating grease
- Cooking oil
- Salt

### 3.3 Power Panel C30 - 4.3" variants

#### 3.3.1 Order data

Model number	Short description	Figure
	<b>Power Panel C30</b>	
4PPC30.043F-21B	Power Panel C30, 4.3", landscape format, fieldbus interfaces: 2x CAN bus. CPU and memory: 1 GHz (ARM Cortex-A8), 256 MB DDRAM, 8 kB FRAM, 512 MB onboard flash drive. Display and touch screen: 4.3", 480 x 272 (WQVGA) resolution, analog resistive touch screen, landscape format, anthracite gray pinstripe. Interfaces: 1x Ethernet 10/100 Mbit/s, 2x USB 2.0, 2x CAN bus.	
4PPC30.043F-22B	Power Panel C30, 4.3", landscape format, fieldbus interfaces: 1x CAN bus, 1x RS232. CPU and memory: 1 GHz (ARM Cortex-A8), 256 MB DDRAM, 8 kB FRAM, 512 MB onboard flash drive. Display and touch screen: 4.3", 480 x 272 (WQVGA) resolution, analog resistive touch screen, landscape format, anthracite gray pinstripe. Interfaces: 1x Ethernet 10/100 Mbit/s, 2x USB 2.0, 1x CAN bus, 1x RS232.	
4PPC30.043F-23B	Power Panel C30, 4.3", landscape format, fieldbus interfaces: 1x CAN bus, 1x RS485. CPU and memory: 1 GHz (ARM Cortex-A8), 256 MB DDRAM, 8 kB FRAM, 512 MB onboard flash drive. Display and touch screen: 4.3", 480 x 272 (WQVGA) resolution, analog resistive touch screen, landscape format, anthracite gray pinstripe. Interfaces: 1x Ethernet 10/100 Mbit/s, 2x USB 2.0, 1x CAN bus, 1x RS485.	
	<b>Included in delivery</b>	
	<b>Terminal blocks</b>	
0TB5106.2110-01	Accessory terminal block, 6-pin (2.5), cage clamp terminal block 0.5 mm <sup>2</sup>	
0TB6102.2110-01	Accessory terminal block, 2-pin (3.81), cage clamp terminal block 1.5 mm <sup>2</sup>	
	<b>Optional accessories</b>	
	<b>Other</b>	
9A0013.01	Stylus pen for resistive touch screen	
	<b>Terminal blocks</b>	
0TB6102.2010-01	Accessory terminal block, 2-pin (3.81), screw clamp terminal block 1.5 mm <sup>2</sup>	
	<b>USB accessories</b>	
5MMUSB.2048-01	USB 2.0 flash drive 2048 MB B&R	
5MMUSB.4096-01	USB 2.0 flash drive 4096 MB B&R	

Table 4: Power Panel C30 - 4.3" variants - Order data

#### Content of delivery

Name	Quantity	Description
0TB5106.2110-01	1	Accessory terminal block, 6-pin (2.5), cage clamp terminal block 0.5 mm <sup>2</sup>
0TB6102.2110-01	1	Accessory terminal block, 2-pin (3.81), cage clamp terminal block 1.5 mm <sup>2</sup>
-	1	C-Series 4.3" accessory plate: Plate for securing the connection lines and connecting the shielding
-	1	Accessory set 3x retaining clip for fastening the panel in the installation cutout

#### 3.3.2 Technical data

Model number	4PPC30.043F-21B	4PPC30.043F-22B	4PPC30.043F-23B
<b>General information</b>			
Cooling	Passive		
B&R ID code	0xE97E	0xF233	0xF181
Power button	No		
Reset button	Yes		
Status indicators	Supply voltage OK, operating state, module status, Ethernet, CAN Rx/Tx	Supply voltage OK, operating state, module status, Ethernet, CAN Rx/Tx, RS232 Rx/Tx	Supply voltage OK, operating state, module status, Ethernet, CAN Rx/Tx, RS485 Rx/Tx
Buzzer	Yes		
Controller redundancy possible	No		
ACOPOS support	No		
Visual Components support	Yes		
Safety support	No		
Certifications	Yes		
CE			
UL	cULus E115267 Industrial control equipment		
<b>Controller</b>			
Bootloader <sup>1)</sup>	Automation Runtime Hardware rev. ≥B1: AR B4.09 Hardware rev. <B1: AR U4.08	Automation Runtime AR 4.09	

Table 5: Power Panel C30 - 4.3" variants - Technical data



Model number	4PPC30.043F-21B	4PPC30.043F-22B	4PPC30.043F-23B
Real-time clock <sup>2)</sup>	Nonvolatile, resolution 1 s, -10 to 10 ppm accuracy at 25°C		
FPU	Yes		
Processor			
Type	ARM Cortex-A8		
Clock frequency	1 GHz		
L1 cache			
Data code	24 kB		
Program code	32 kB		
L2 cache	256 kB		
Mode/Node switches	No		
Remanent variables	8 kB FRAM, retention >10 years <sup>3)</sup>		
DRAM	256 MB		
Shortest task class cycle time	1 ms		
Typical instruction cycle time	0.01 µs		
Application memory			
Type	512 MB flash memory		
Data retention	10 years		
Writable data amount			
Guaranteed	40 TB		
Results for 5 years	21.9 GB/day		
Guaranteed erase/write cycles	20,000		
Error correction coding (ECC)	Yes		
Temperature cutoff	No		
<b>Interfaces</b>			
Interface IF1			
Type	USB 2.0		
Variant	Type A		
Current-carrying capacity	0.49 A		
Interface IF2			
Type	USB 2.0		
Variant	Type A		
Current-carrying capacity	0.49 A		
Interface IF3			
Type	Ethernet		
Variant	1x RJ45 shielded		
Line length	Max. 100 m between 2 nodes (segment length)		
Max. transfer rate	10/100 Mbit/s		
Transfer			
Physical layer	10BASE-T/100BASE-TX		
Half-duplex	Yes		
Full-duplex	Yes		
Autonegotiation	Yes		
Auto-MDI / MDIX	Yes		
Interface IF4			
Type	CAN bus		
Variant	3 pins of the 6-pin multipoint connector		
Bus terminating resistor	120 Ω, can be switched using software <sup>4)</sup>		
Max. distance	1000 m		
Max. transfer rate			
Bus length ≤25 m	1 Mbit/s		
Bus length ≤60 m	500 kbit/s		
Bus length ≤200 m	250 kbit/s		
Bus length ≤1000 m	50 kbit/s		
Interface IF5			
Type	-	RS485	
Variant	-	3 pins of the 6-pin multipoint connector	
Max. distance	-	1200 m	
Transfer rate	-	Max. 115.2 kbit/s	
Interface IF6			
Type	CAN bus	-	
Variant	3 pins of the 6-pin multipoint connector	-	
Bus terminating resistor	120 Ω, can be switched using software <sup>4)</sup>	-	
Max. distance	1000 m	-	
Max. transfer rate		-	
Bus length ≤25 m	1 Mbit/s	-	
Bus length ≤60 m	500 kbit/s	-	
Bus length ≤200 m	250 kbit/s	-	
Bus length ≤1000 m	50 kbit/s	-	

Table 5: Power Panel C30 - 4.3" variants - Technical data

Device description • Power Panel C30 - 4.3" variants

Model number	4PPC30.043F-21B	4PPC30.043F-22B	4PPC30.043F-23B
<b>Interface IF8</b>			
Type	-	RS232	-
Variant	-	3 pins of the 6-pin multipoint connector	-
Max. distance	-	900 m	-
Transfer rate	-	Max. 115.2 kbit/s	-
<b>Display</b>			
Type	TFT color		
Diagonal	4.3"		
Colors	16.7 million (RGB, 8 bits per channel)		
Resolution	WQVGA, 480 x 272 pixels		
Contrast	Typ. 350:1		
<b>Viewing angles</b>			
Horizontal	Direction L / Direction R = Typ. 70°		
Vertical	Direction U = Typ. 50° / Direction D = Typ. 70°		
<b>Backlight</b>			
Type	LED		
Brightness	Typ. 450 cd/m <sup>2</sup>		
Half-brightness time <sup>5)</sup>	30,000 h		
<b>Touch screen</b>			
Type	AMT		
Technology	Analog resistive		
Controller	B&R, 12-bit		
Transmittance	80% ±3%		
Screen rotation	Yes		
<b>Electrical characteristics</b>			
Nominal voltage	24 VDC -15% / +20%		
Power consumption <sup>6)</sup>	Typ. 3.5 W / Max. 12.5 W		
Fuse	3 A slow-blow, internal <sup>7)</sup>		
Reverse polarity protection	Yes		
Electrical isolation	Ethernet (IF3) to other interfaces and to device		
<b>Operating conditions</b>			
<b>Installation elevation above sea level</b>			
0 to 2000 m	No limitation		
>2000 m	Reduction of ambient temperature by 0.5°C per 100 m		
Degree of protection per EN 60529	Front: IP65, Back: IP20		
<b>Environmental conditions</b>			
<b>Temperature</b>			
Operation	-20 to 60°C		
Storage	-25 to 70°C		
Transport	-25 to 70°C		
Relative humidity	5 to 95%, non-condensing		
<b>Mechanical properties</b>			
<b>Front</b>			
Design	Anthracite gray pinstripe		
<b>Dimensions</b>			
Width	140 mm		
Height	96 mm		
Depth	38.3 mm		
Weight	0.3 kg		

Table 5: Power Panel C30 - 4.3" variants - Technical data

- 1) The Automation Runtime version depends on the hardware revision of the Power Panel.
- 2) The real-time clock is buffered for approx. 1000 hours @ 25°C by a gold foil capacitor. The gold foil capacitor is completely charged after 3 continuous hours of operation.
- 3) The size of the memory used for remanent variables is configurable in Automation Studio.
- 4) The functionality for switching on the terminating resistor using software is available with Automation Studio 4.3.1 and later as well as Automation Runtime 4.31 and later.
- 5) At an ambient temperature of 25°C. Reducing the brightness by 50% can result in an approximately 50% increase in the half-brightness time.
- 6) Power consumption including all interfaces.
- 7) The internal fuse cannot be replaced by the user or reset.

### 3.3.3 Dimensions

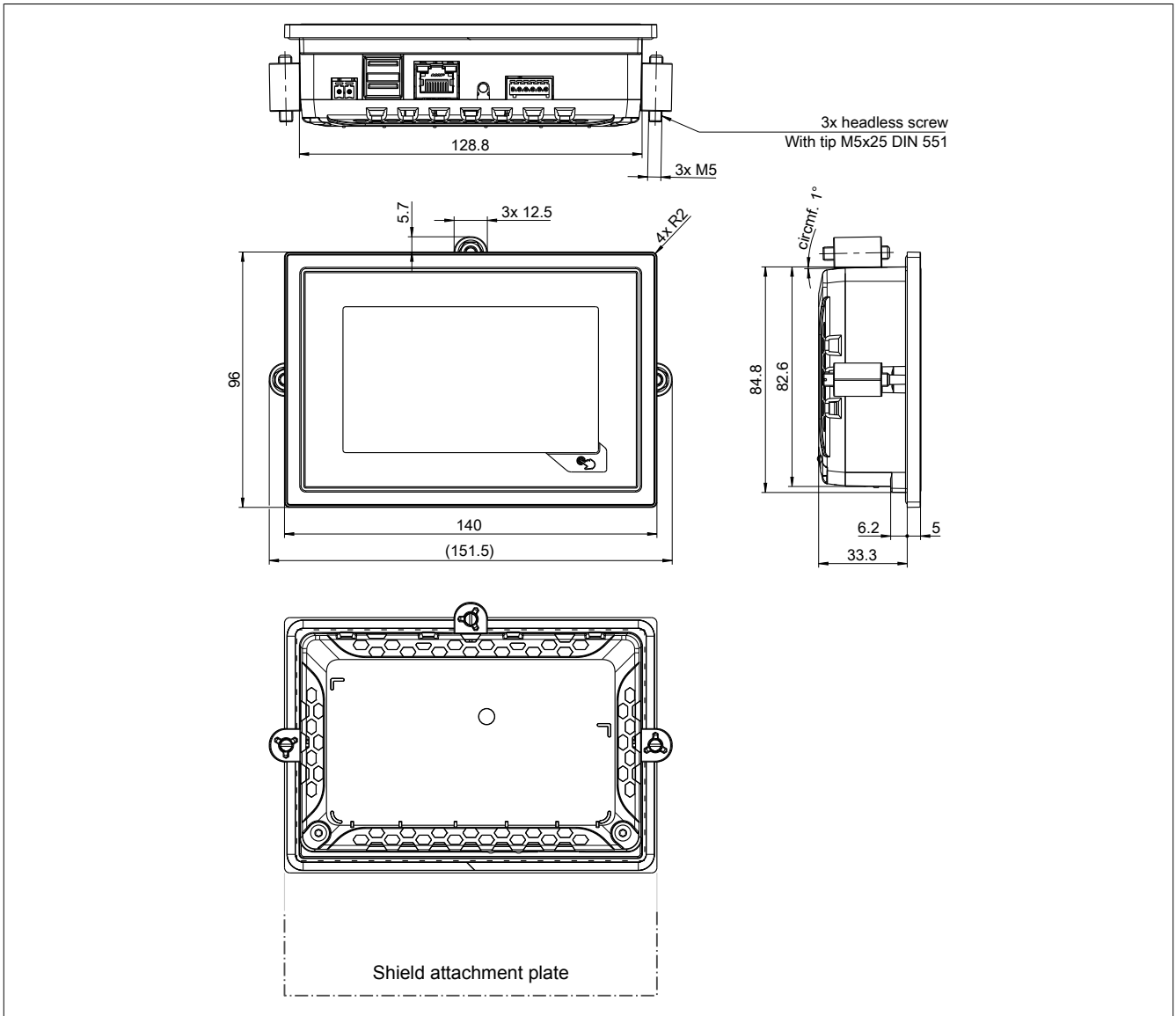

Shield attachment plate, see [Mounting shield attachment plate for 4.3" Power Panel](#), page 38

Dimensions of the installation cutout for this Power Panel variant: 130.8 ±1 mm x 86.8 ±1 mm

See also "[Installation cutout requirements](#)" on page 36.

## 3.4 Power Panel C30 - 7.0" variants

### 3.4.1 Order data

Model number	Short description	Figure
	<b>Power Panel C30</b>	
4PPC30.0702-21B	Power Panel C30, 7.0", landscape format, fieldbus interfaces: 2x CAN bus. CPU and memory: 1 GHz (ARM Cortex-A8), 256 MB DDRAM, 8 kB FRAM, 512 MB onboard flash drive. Display and touch screen: 7.0", 800 x 480 (WVGA) resolution, analog resistive touch screen, landscape format, anthracite gray pinstripe. Interfaces: 1x Ethernet 10/100 Mbit/s, 2x USB 2.0, 2x CAN bus.	
4PPC30.0702-22B	Power Panel C30, 7.0", landscape format, fieldbus interfaces: 1x CAN bus, 1x RS232. CPU and memory: 1 GHz (ARM Cortex A8), 256 MB DDRAM, 8 kB FRAM, 512 MB onboard flash drive. Display and touch screen: 7.0", 800 x 480 (WVGA) resolution, analog resistive touch screen, landscape format, anthracite gray pinstripe. Interfaces: 1x Ethernet 10/100 Mbit/s, 2x USB 2.0, 1x CAN bus, 1x RS232.	
4PPC30.0702-23B	Power Panel C30, 7.0", landscape format, fieldbus interfaces: 1x CAN bus, 1x RS485. CPU and memory: 1 GHz (ARM Cortex A8), 256 MB DDRAM, 8 kB FRAM, 512 MB onboard flash drive. Display and touch screen: 7.0", 800 x 480 (WVGA) resolution, analog resistive touch screen, landscape format, anthracite gray pinstripe. Interfaces: 1x Ethernet 10/100 Mbit/s, 2x USB 2.0, 1x CAN bus, 1x RS485.	
	<b>Included in delivery</b>	
	<b>Terminal blocks</b>	
0TB5106.2110-01	Accessory terminal block, 6-pin (2.5), cage clamp terminal block 0.5 mm <sup>2</sup>	
0TB6102.2110-01	Accessory terminal block, 2-pin (3.81), cage clamp terminal block 1.5 mm <sup>2</sup>	
	<b>Optional accessories</b>	
	<b>Other</b>	
9A0013.01	Stylus pen for resistive touch screen	
	<b>Terminal blocks</b>	
0TB6102.2010-01	Accessory terminal block, 2-pin (3.81), screw clamp terminal block 1.5 mm <sup>2</sup>	
	<b>USB accessories</b>	
5MMUSB.2048-01	USB 2.0 flash drive 2048 MB B&R	
5MMUSB.4096-01	USB 2.0 flash drive 4096 MB B&R	

Table 6: Power Panel C30 - 7.0" variants - Order data

### Content of delivery

Description	Quantity	Description
0TB5106.2110-01	1	Accessory terminal block, 6-pin (2.5), cage clamp terminal block 0.5 mm <sup>2</sup>
0TB6102.2110-01	1	Accessory terminal block, 2-pin (3.81), cage clamp terminal block 1.5 mm <sup>2</sup>
-	1	Accessory set 5x retaining clip for securing the panel in the installation cutout

### 3.4.2 Technical data

Model number	4PPC30.0702-21B	4PPC30.0702-22B	4PPC30.0702-23B
<b>General information</b>			
Cooling	Passive		
B&R ID code	0xE97F	0xF234	0xF180
Power button	No		
Reset button	Yes		
Status indicators	Supply voltage OK, operating state, module status, Ethernet, CAN Rx/Tx	Supply voltage OK, operating state, module status, Ethernet, CAN Rx/Tx, RS232 Rx/Tx	Supply voltage OK, operating state, module status, Ethernet, CAN Rx/Tx, RS485 Rx/Tx
Buzzer	Yes		
Controller redundancy possible	No		
ACOPOS support	No		
Visual Components support	Yes		
Safety support	No		
Certifications	Yes		
CE	-		
UL	cULus E115267 Industrial control equipment	-	
<b>Controller</b>			
Bootloader <sup>1)</sup>	Automation Runtime Hardware Rev. ≥B1: AR B4.09 Hardware Rev. <B1: AR U4.08	Automation Runtime AR 4.09	
Real-time clock <sup>2)</sup>	Nonvolatile, resolution 1 s, -10 to 10 ppm accuracy at 25°C		

Table 7: Power Panel C30 - 7.0" variants - Technical data

Model number	4PPC30.0702-21B	4PPC30.0702-22B	4PPC30.0702-23B
FPU		Yes	
Processor			
Type		ARM Cortex-A8	
Clock frequency		1 GHz	
L1 cache			
Data code		24 kB	
Program code		32 kB	
L2 cache		256 kB	
Mode/Node switches		No	
Remanent variables		8 kB FRAM, retention >10 years <sup>3)</sup>	
DRAM		256 MB	
Shortest task class cycle time		1 ms	
Typical instruction cycle time		0.01 µs	
Application memory			
Type		512 MB flash memory	
Data retention		10 years	
Writable data amount			
Guaranteed		40 TB	
Results for 5 years		21.9 GB/day	
Guaranteed erase/write cycles		20,000	
Error correction coding (ECC)		Yes	
Temperature cutoff		No	
<b>Interfaces</b>			
Interface IF1			
Type		USB 2.0	
Variant		Type A	
Current-carrying capacity		0.49 A	
Interface IF2			
Type		USB 2.0	
Variant		Type A	
Current-carrying capacity		0.49 A	
Interface IF3			
Type		Ethernet	
Variant		1x RJ45 shielded	
Line length		Max. 100 m between 2 nodes (segment length)	
Max. transfer rate		10/100 Mbit/s	
Transfer			
Physical layer		10BASE-T/100BASE-TX	
Half-duplex		Yes	
Full-duplex		Yes	
Autonegotiation		Yes	
Auto-MDI / MDIX		Yes	
Interface IF4			
Type		CAN bus	
Variant		3 pins of the 6-pin multipoint connector	
Bus terminating resistor		120 Ω, can be switched using software <sup>4)</sup>	
Max. distance		1000 m	
Max. transfer rate			
Bus length ≤25 m		1 Mbit/s	
Bus length ≤60 m		500 kbit/s	
Bus length ≤200 m		250 kbit/s	
Bus length ≤1000 m		50 kbit/s	
Interface IF5			
Type		-	RS485
Variant		-	3 pins of the 6-pin multipoint connector
Max. distance		-	1200 m
Transfer rate		-	Max. 115.2 kbit/s
Interface IF6			
Type		CAN bus	-
Variant		3 pins of the 6-pin multipoint connector	-
Bus terminating resistor		120 Ω, can be switched using software <sup>4)</sup>	-
Max. distance		1000 m	-
Max. transfer rate			
Bus length ≤25 m		1 Mbit/s	-
Bus length ≤60 m		500 kbit/s	-
Bus length ≤200 m		250 kbit/s	-
Bus length ≤1000 m		50 kbit/s	-

Table 7: Power Panel C30 - 7.0" variants - Technical data

Device description • Power Panel C30 - 7.0" variants

Model number	4PPC30.0702-21B	4PPC30.0702-22B	4PPC30.0702-23B
<b>Interface IF8</b>			
Type	-	RS232	-
Variant	-	3 pins of the 6-pin multipoint connector	-
Max. distance	-	900 m	-
Transfer rate	-	Max. 115.2 kbit/s	-
<b>Display</b>			
Type	TFT color		
Diagonal	7.0"		
Colors	16.7 million (RGB, 8 bits per channel)		
Resolution	WVGA, 800 x 480 pixels		
Contrast	Typ. 600:1		
<b>Viewing angles</b>			
Horizontal	Direction L / Direction R = Typ. 70°		
Vertical	Direction U / Direction D = Typ. 60°		
<b>Backlight</b>			
Type	LED		
Brightness	Typ. 500 cd/m <sup>2</sup>		
Half-brightness time <sup>5)</sup>	50,000 h		
<b>Touch screen</b>			
Type	AMT		
Technology	Analog resistive		
Controller	B&R, 12-bit		
Transmittance	80% ±3%		
Screen rotation	Yes		
<b>Electrical characteristics</b>			
Nominal voltage	24 VDC -15% / +20%		
Power consumption <sup>6)</sup>	Typ. 6 W / Max. 12.5 W		
Fuse	3 A slow-blow, internal <sup>7)</sup>		
Reverse polarity protection	Yes		
Electrical isolation	Ethernet (IF3) to other interfaces and to device		
<b>Operating conditions</b>			
<b>Installation elevation above sea level</b>			
0 to 2000 m	No limitation		
>2000 m	Reduction of ambient temperature by 0.5°C per 100 m		
Degree of protection per EN 60529	Front: IP65, Back: IP20		
<b>Environmental conditions</b>			
<b>Temperature</b>			
Operation	-20 to 60°C		
Storage	-25 to 70°C		
Transport	-25 to 70°C		
Relative humidity	5 to 95%, non-condensing		
<b>Mechanical properties</b>			
<b>Front</b>			
Design	Anthracite gray pinstripe		
<b>Dimensions</b>			
Width	197 mm		
Height	140 mm		
Depth	47.8 mm		
Weight	0.6 kg		

Table 7: Power Panel C30 - 7.0" variants - Technical data

- 1) The Automation Runtime version depends on the hardware revision of the Power Panel.
- 2) The real-time clock is buffered for approx. 1000 hours @ 25°C by a gold foil capacitor. The gold foil capacitor is completely charged after 3 continuous hours of operation.
- 3) The size of the memory used for remanent variables is configurable in Automation Studio.
- 4) The functionality for switching on the terminating resistor using software is available with Automation Studio 4.3.1 and later as well as Automation Runtime 4.31 and later.
- 5) At an ambient temperature of 25°C. Reducing the brightness by 50% can result in an approximately 50% increase in the half-brightness time.
- 6) Power consumption including all interfaces.
- 7) The internal fuse cannot be replaced by the user or reset.

### 3.4.3 Dimensions

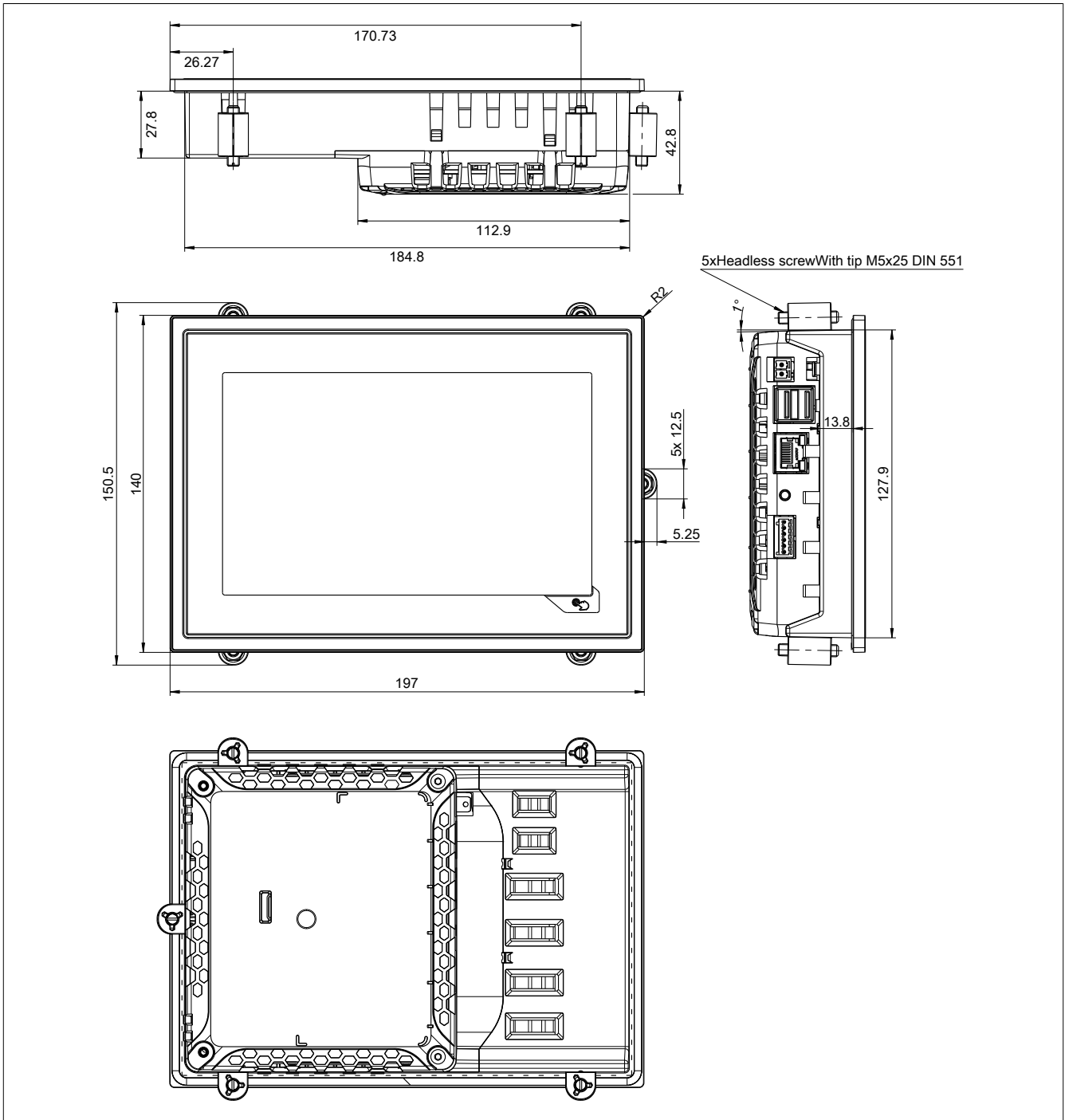

Dimensions of the installation cutout for this Power Panel variant: 186.8 ±1 mm x 129.8 ±1 mm

See also "Installation cutout requirements" on page 36.

## 3.5 Power Panel C30 - 10.1" variants

### 3.5.1 Order data

Model number	Short description	Figure
	<b>Power Panel C30</b>	
4PPC30.101G-21B	Power Panel C30, 10.1", landscape format, fieldbus interfaces: 2x CAN bus. CPU and memory: 1 GHz (ARM Cortex-A8), 256 MB DDRAM, 8 kB FRAM, 512 MB onboard flash drive. Display and touch screen: 10.1", 1024 x 600 (WSVGA) resolution, analog resistive touch screen, landscape format, anthracite gray pinstripe. Interfaces: 1x Ethernet 10/100 Mbit/s, 2x USB 2.0, 2x CAN bus.	
4PPC30.101G-22B	Power Panel C30, 10.1", landscape format, fieldbus interfaces: 1x CAN bus, 1x RS232. CPU and memory: 1 GHz (ARM Cortex-A8), 256 MB DDRAM, 8 kB FRAM, 512 MB onboard flash drive. Display and touch screen: 10.1", 1024 x 600 (WSVGA) resolution, analog resistive touch screen, landscape format, anthracite gray pinstripe. Interfaces: 1x Ethernet 10/100 Mbit/s, 2x USB 2.0, 1x CAN bus, 1x RS232.	
4PPC30.101G-23B	Power Panel C30, 10.1", landscape format, fieldbus interfaces: 1x CAN bus, 1x RS485. CPU and memory: 1 GHz (ARM Cortex-A8), 256 MB DDRAM, 8 kB FRAM, 512 MB onboard flash drive. Display and touch screen: 10.1", 1024 x 600 (WSVGA) resolution, analog resistive touch screen, landscape format, anthracite gray pinstripe. Interfaces: 1x Ethernet 10/100 Mbit/s, 2x USB 2.0, 1x CAN bus, 1x RS485.	
	<b>Included in delivery</b>	
	<b>Terminal blocks</b>	
0TB5106.2110-01	Accessory terminal block, 6-pin (2.5), cage clamp terminal block 0.5 mm <sup>2</sup>	
0TB6102.2110-01	Accessory terminal block, 2-pin (3.81), cage clamp terminal block 1.5 mm <sup>2</sup>	
	<b>Optional accessories</b>	
	<b>Other</b>	
9A0013.01	Stylus pen for resistive touch screen	
	<b>Terminal blocks</b>	
0TB6102.2010-01	Accessory terminal block, 2-pin (3.81), screw clamp terminal block 1.5 mm <sup>2</sup>	
	<b>USB accessories</b>	
5MMUSB.2048-01	USB 2.0 flash drive 2048 MB B&R	
5MMUSB.4096-01	USB 2.0 flash drive 4096 MB B&R	

Table 8: Power Panel C30 - 10.1" variants - Order data

### Content of delivery

Description	Quantity	Description
0TB5106.2110-01	1	Accessory terminal block, 6-pin (2.5), cage clamp terminal block 0.5 mm <sup>2</sup>
0TB6102.2110-01	1	Accessory terminal block, 2-pin (3.81), cage clamp terminal block 1.5 mm <sup>2</sup>
-	1	Accessory set 6x retaining clip for fastening the panel in the installation cutout

### 3.5.2 Technical data

Model number	4PPC30.101G-21B	4PPC30.101G-22B	4PPC30.101G-23B
<b>General information</b>			
Cooling	Passive		
B&R ID code	0xF358	0xF359	0xF35A
Power button	No		
Reset button	Yes		
Status indicators	Supply voltage OK, operating state, module status, Ethernet, CAN Rx/Tx	Supply voltage OK, operating state, module status, Ethernet, CAN Rx/Tx, RS232 Rx/Tx	Supply voltage OK, operating state, module status, Ethernet, CAN Rx/Tx, RS485 Rx/Tx
Buzzer	Yes		
Controller redundancy possible	No		
ACOPOS support	No		
Visual Components support	Yes		
Safety support	No		
Certifications	Yes		
CE	Yes		
<b>Controller</b>			
Bootloader	Automation Runtime AR 4.09		
Real-time clock <sup>1)</sup>	Nonvolatile, resolution 1 s, -10 to 10 ppm accuracy at 25°C		
FPU	Yes		

Table 9: Power Panel C30 - 10.1" display - Technical data



Model number	4PPC30.101G-21B	4PPC30.101G-22B	4PPC30.101G-23B
<b>Processor</b>			
Type		ARM Cortex-A8	
Clock frequency		1 GHz	
<b>L1 cache</b>			
Data code		24 kB	
Program code		32 kB	
<b>L2 cache</b>			
		256 kB	
Mode/Node switches		No	
Remanent variables		8 kB FRAM, retention >10 years <sup>2)</sup>	
DRAM		256 MB	
Shortest task class cycle time		1 ms	
Typical instruction cycle time		0.01 µs	
<b>Application memory</b>			
Type		512 MB flash memory	
Data retention		10 years	
<b>Writable data amount</b>			
Guaranteed		40 TB	
Results for 5 years		21.9 GB/day	
Guaranteed erase/write cycles		20,000	
Error correction coding (ECC)		Yes	
Temperature cutoff		No	
<b>Interfaces</b>			
<b>Interface IF1</b>			
Type		USB 2.0	
Variant		Type A	
Current-carrying capacity		0.49 A	
<b>Interface IF2</b>			
Type		USB 2.0	
Variant		Type A	
Current-carrying capacity		0.49 A	
<b>Interface IF3</b>			
Type		Ethernet	
Variant		1x RJ45 shielded	
Line length		Max. 100 m between 2 nodes (segment length)	
Max. transfer rate		10/100 Mbit/s	
<b>Transfer</b>			
Physical layer		10BASE-T/100BASE-TX	
Half-duplex		Yes	
Full-duplex		Yes	
Autonegotiation		Yes	
Auto-MDI / MDIX		Yes	
<b>Interface IF4</b>			
Type		CAN bus	
Variant		3 pins of the 6-pin multipoint connector	
Bus terminating resistor		120 Ω, can be switched using software <sup>3)</sup>	
Max. distance		1000 m	
<b>Max. transfer rate</b>			
Bus length ≤25 m		1 Mbit/s	
Bus length ≤60 m		500 kbit/s	
Bus length ≤200 m		250 kbit/s	
Bus length ≤1000 m		50 kbit/s	
<b>Interface IF5</b>			
Type		-	RS485
Variant		-	3 pins of the 6-pin multipoint connector
Max. distance		-	1200 m
Transfer rate		-	Max. 115.2 kbit/s
<b>Interface IF6</b>			
Type	CAN bus		-
Variant	3 pins of the 6-pin multipoint connector		-
Bus terminating resistor	120 Ω, can be switched using software <sup>3)</sup>		-
Max. distance	1000 m		-
<b>Max. transfer rate</b>			
Bus length ≤25 m	1 Mbit/s		-
Bus length ≤60 m	500 kbit/s		-
Bus length ≤200 m	250 kbit/s		-
Bus length ≤1000 m	50 kbit/s		-

Table 9: Power Panel C30 - 10.1" display - Technical data

Device description • Power Panel C30 - 10.1" variants

Model number	4PPC30.101G-21B	4PPC30.101G-22B	4PPC30.101G-23B
<b>Interface IF8</b>			
Type	-	RS232	-
Variant	-	3 pins of the 6-pin multipoint connector	-
Max. distance	-	900 m	-
Transfer rate	-	Max. 115.2 kbit/s	-
<b>Display</b>			
Type	TFT color		
Diagonal	10.1"		
Colors	16.7 million (RGB, 8 bits per channel)		
Resolution	WSVGA, 1024 x 600 pixels		
Contrast	Typ. 500:1		
Viewing angles			
Horizontal	Direction L / Direction R = Typ. 80°		
Vertical	Direction U / Direction D = Typ. 80°		
Backlight			
Type	LED		
Brightness	Typ. 500 cd/m <sup>2</sup>		
Half-brightness time <sup>4)</sup>	50,000 h		
Touch screen			
Type	AMT		
Technology	Analog resistive		
Controller	B&R, 12-bit		
Transmittance	80% ±3%		
Screen rotation	Yes		
<b>Electrical characteristics</b>			
Nominal voltage	24 VDC -15% / +20%		
Power consumption <sup>5)</sup>	Typ. 6.5 W / Max. 12.5 W		
Fuse	3 A slow-blow, internal <sup>6)</sup>		
Reverse polarity protection	Yes		
Electrical isolation	Ethernet (IF3) to other interfaces and to device		
<b>Operating conditions</b>			
Installation elevation above sea level			
0 to 2000 m	No limitation		
>2000 m	Reduction of ambient temperature by 0.5°C per 100 m		
Degree of protection per EN 60529	Front: IP65, Back: IP20		
<b>Environmental conditions</b>			
Temperature			
Operation	-20 to 60°C		
Storage	-25 to 70°C		
Transport	-25 to 70°C		
Relative humidity	5 to 95%, non-condensing		
<b>Mechanical properties</b>			
Front			
Design	Anthracite gray pinstripe		
Dimensions			
Width	276 mm		
Height	172 mm		
Depth	47.8 mm		
Weight	0.9 kg		

Table 9: Power Panel C30 - 10.1" display - Technical data

- 1) The real-time clock is backed up for approx. 1000 hours @ 25°C by a gold foil capacitor. The gold foil capacitor is completely charged after 3 continuous hours of operation.
- 2) The size of the memory used for remanent variables is configurable in Automation Studio.
- 3) The functionality for switching on the terminating resistor using software is available with Automation Studio 4.3.1 and later as well as Automation Runtime 4.31 and later.
- 4) At an ambient temperature of 25°C.
- 5) Power consumption including all interfaces.
- 6) The internal fuse cannot be replaced by the user or reset.

### 3.5.3 Dimensions

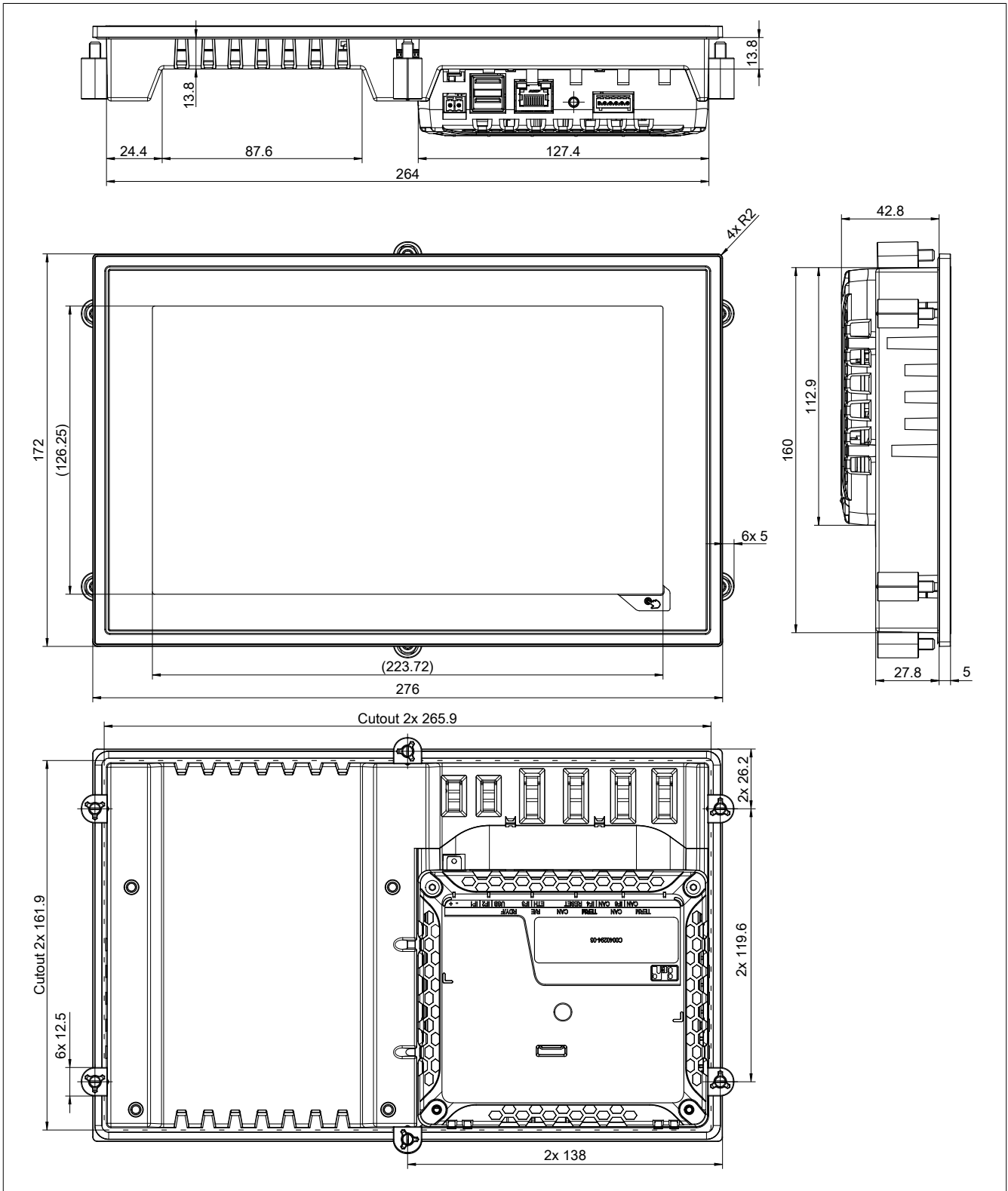

Dimensions of the installation cutout for this Power Panel variant: 265.9 ±1 mm x 161.9 ±1 mm

See also "[Installation cutout requirements](#)" on page 36.

### 3.6 Diagnostic LEDs

The diagnostic LEDs are located on the back of the Power Panel:

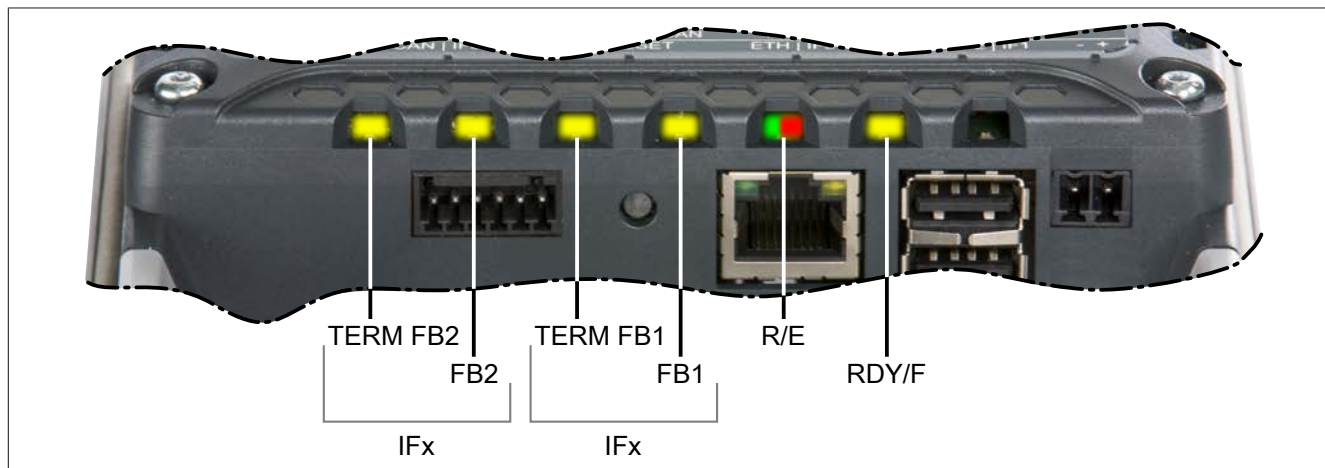

LED	Color	Status	Description
RDY/F	Yellow	On	Mode BOOT, SERVICE or DIAGNOSIS
		Blinking	If LED "R/E" blinks red and LED "RDY/F" blinks yellow, a license violation has occurred.
R/E	Green	On	Mode RUN: The application is running.
		On	Mode BOOT, SERVICE or DIAGNOSIS
		Blinking	If LED "R/E" blinks red and LED "RDY/F" blinks yellow, a license violation has occurred.
FB1			
TERM FB1	These LEDs (FB1/2: Fieldbus 1/2) have a different meaning depending on the Power Panel variant.		
FB2	See the description in the following sections.		
Term FB2			

#### Fieldbus LEDs - Variant with 2x CAN bus

LED	Color	Status	Description	IFx	
FB1	CAN	Yellow	On	Data is being transmitted or received via the CAN bus interface.	IF4
TERM FB1	TERM	Yellow	On	The integrated terminating resistor for the CAN bus interface is switched on. <sup>1)</sup>	
FB2	CAN	Yellow	On	Data is being transmitted or received via the CAN bus interface.	IF6
Term FB2	TERM	Yellow	On	The integrated terminating resistor for the CAN bus interface is switched on. <sup>1)</sup>	

1) The functionality for switching on the terminating resistor using software is available with Automation Studio 4.3.1 and later as well as Automation Runtime 4.31 and later.

#### Fieldbus LEDs - Variant with 1x CAN bus and 1x RS232

LED	Color	Status	Description	IFx	
FB1	CAN	Yellow	On	Data is being transmitted or received via the CAN bus interface.	IF4
TERM FB1	TERM	Yellow	On	The integrated terminating resistor for the CAN bus interface is switched on. <sup>1)</sup>	
FB2	RS232	Yellow	On	Data is being transmitted or received via the RS232 interface.	IF8
Term FB2	-				

1) The functionality for switching on the terminating resistor using software is available with Automation Studio 4.3.1 and later as well as Automation Runtime 4.31 and later.

#### Fieldbus LEDs - Variant with 1x CAN bus and 1x RS485

LED	Color	Status	Description	IFx	
FB1	CAN	Yellow	On	Data is being transmitted or received via the CAN bus interface.	IF4
TERM FB1	TERM	Yellow	On	The integrated terminating resistor for the CAN bus interface is switched on. <sup>1)</sup>	
FB2	RS485	Yellow	On	Data is being transmitted or received via the RS485 interface.	IF5
Term FB2	TERM	Yellow	On	The integrated terminating resistor for the RS485 interface is switched on. <sup>1)</sup>	

1) The functionality for switching on the terminating resistor using software is available with Automation Studio 4.3.1 and later as well as Automation Runtime 4.31 and later.

### 3.7 Reset button / Operating modes

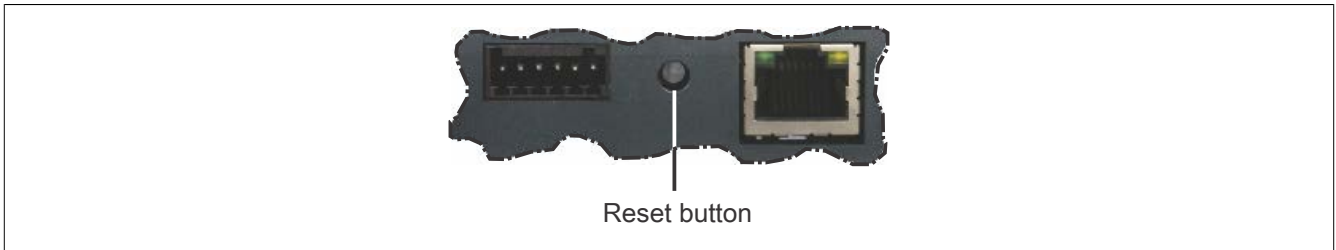

The reset button can be used to switch to one of 3 operating modes. The following key codes are used to select the desired operating mode:

Key code	Operating mode <sup>1)</sup>	Description
Press key briefly (<2 s).	RUN	<p>A <b>hardware reset</b> is triggered.</p> <ul style="list-style-type: none"> <li>• All application programs are stopped.</li> <li>• The outputs of all connected modules are set to zero.</li> </ul> <p>The device then starts up in <b>mode RUN</b> and an existing application is started. The device starts up in mode SERVICE by default. The startup mode that follows after pressing the reset button can be defined in Automation Studio.</p> <ul style="list-style-type: none"> <li>• Mode SERVICE (default)</li> <li>• Warm restart</li> <li>• Cold restart</li> <li>• Mode DIAGNOSIS</li> </ul>
Press and hold key (>2 s).	DIAGNOSIS	The device is started in <b>mode DIAGNOSIS</b> . Program sections in User RAM and in the User FlashPROM are not initialized. A warm restart always take place after exiting mode DIAGNOSIS.
Press key briefly (<2 s). Pause (<2 s) Press and hold key (>2 s).	BOOT	The device changes to <b>mode BOOT</b> . Default Automation Runtime is started. In this mode, the runtime system can be installed with Automation Studio via the online interface. User flash memory is erased only when the download begins.

1) The operating mode can be seen in the display during the startup phase of the device.

Mode RUN is always enabled if a warm or cold restart of the device is triggered with Automation Studio.

## 3.8 Connection elements

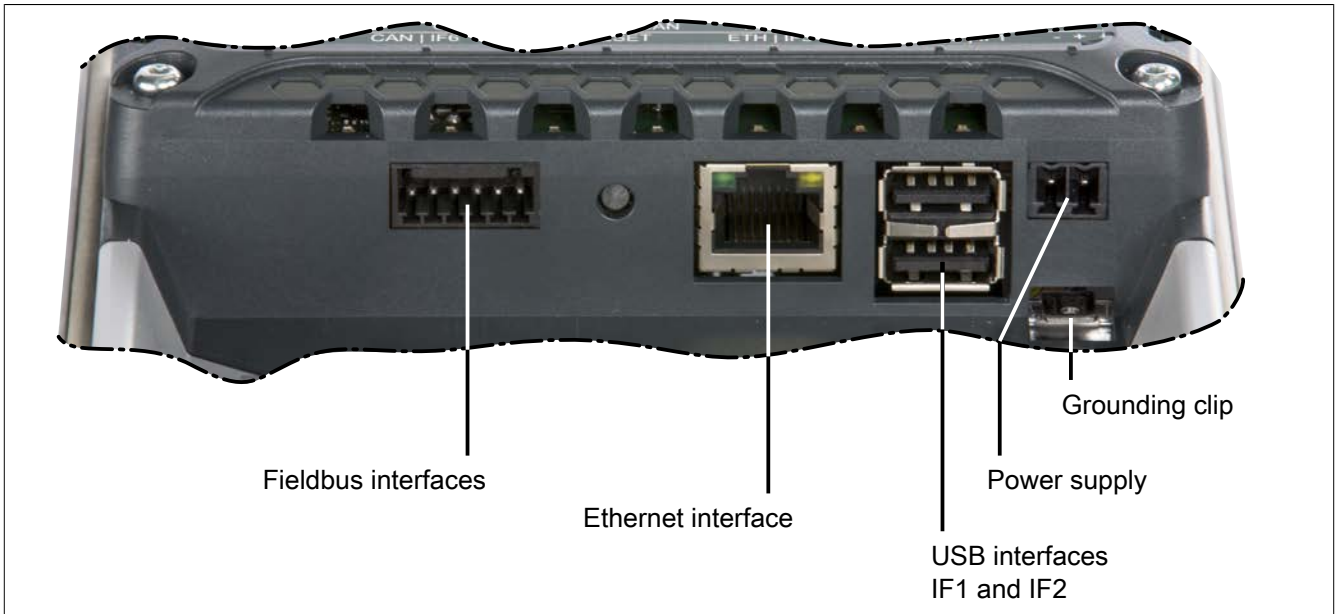

### 3.8.1 Fieldbus interfaces

Terminating resistors are integrated on some fieldbus interfaces; they can be optionally switched on using software (configuration in Automation Studio).

#### **Important!**

The terminating resistors are generally not active during the device's startup phase and after device failure. This can result in problems while the bus is being operated.

Take this behavior into account when designing the network.

Behavior looks like this after the startup phase depending on the version of Automation Studio (AS) and Automation Runtime (AR):

- In AS 4.3.1 and later and AR 4.31 and later, the terminating resistors are only switched on or remain switched off after device startup.  
Default setting of configuration: Terminating resistors are switched off.
- In AR 4.26, the terminating resistors are always disabled. If a terminating resistor is necessary, it must be wired externally to the terminal block.
- In AR <4.26, the terminating resistors are always enabled.

### 3.8.1.1 2x CAN bus interface

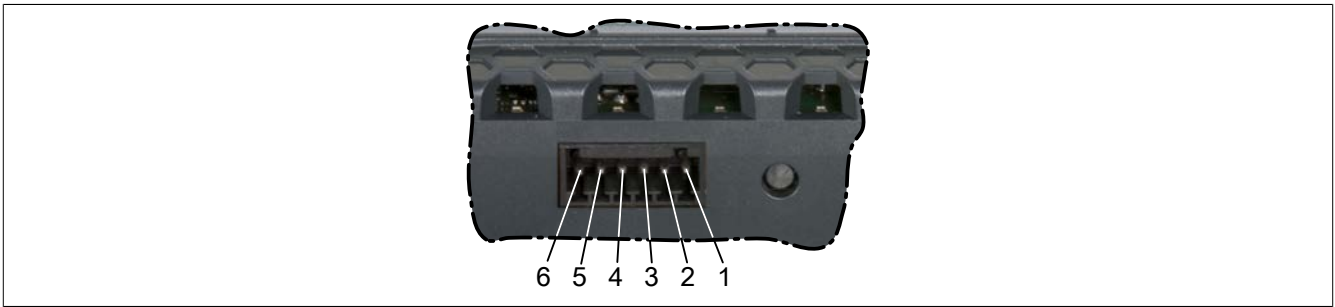

CAN bus			
Terminal			Pinout
1	CAN_H	IF4 CAN bus	CAN high
2	GND		Ground
3	CAN_L		CAN low
4	CAN_H	IF6 CAN bus	CAN high
5	GND		Ground
6	CAN_L		CAN low

#### Required accessories

0TB5106.2110-01	Accessory terminal block, 6-pin (2.5), cage clamp terminal block 0.5 mm <sup>2</sup>
-----------------	--

A terminating resistor can be switched on individually and independently for each interface via software (configuration in Automation Studio).<sup>1)</sup>

### 3.8.1.2 1x CAN bus and 1x RS232 interface

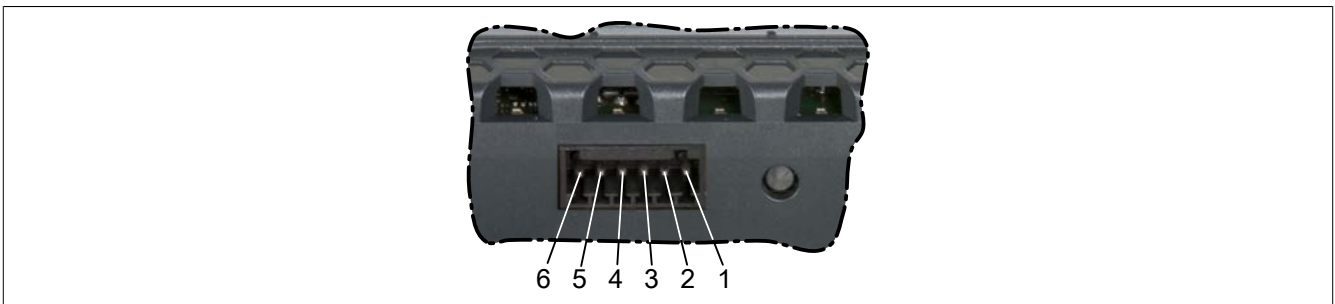

1x CAN bus, 1x RS232			
Terminal			Pinout
1	CAN_H	IF4 CAN bus	CAN high
2	GND		Ground
3	CAN_L		CAN low
4	TxD	IF8 RS232	Transmit signal
5	GND		Ground
6	RxD		Receive signal

#### Required accessories

0TB5106.2110-01	Accessory terminal block, 6-pin (2.5), cage clamp terminal block 0.5 mm <sup>2</sup>
-----------------	--

A terminating resistor can be switched on for the CAN bus interface via software (configuration in Automation Studio).<sup>2)</sup>

<sup>1)</sup> The functionality for switching on the terminating resistor using software is available with Automation Studio 4.3.1 and later as well as Automation Runtime 4.31 and later.

<sup>2)</sup> The functionality for switching on the terminating resistor using software is available with Automation Studio 4.3.1 and later as well as Automation Runtime 4.31 and later.

### 3.8.1.3 1x CAN bus and 1x RS485 interface

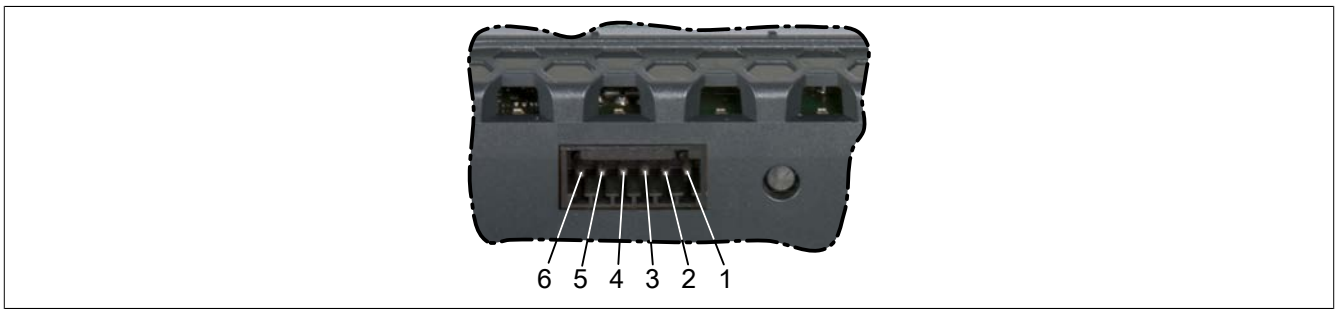

1x CAN bus, 1x RS485			
Terminal	Pinout		
1	CAN_H	IF4 CAN bus	CAN high
2	GND		Ground
3	CAN_L		CAN low
4	DATA	IF5 RS485	Data
5	GND		Ground
6	DATA\		Data inverted

Required accessories	
0TB5106.2110-01	Accessory terminal block, 6-pin (2.5), cage clamp terminal block 0.5 mm <sup>2</sup>

A terminating resistor can be switched on individually and independently for each interface via software (configuration in Automation Studio).<sup>3)</sup>

### 3.8.2 Ethernet interface

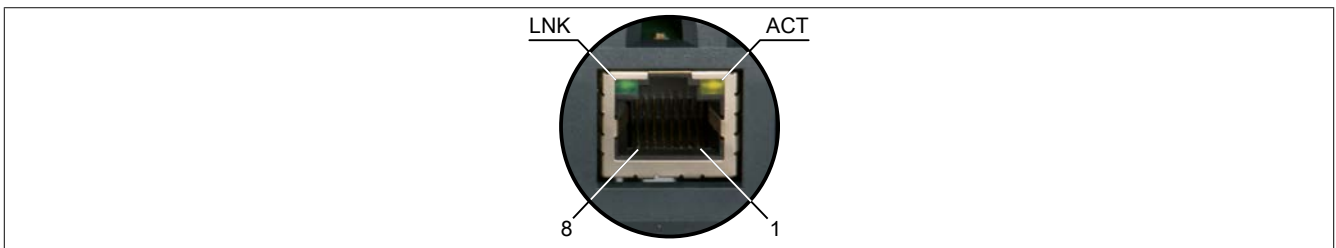

Terminal	Assignment	Explanation	
1	RXD	Receive signal	
2	RXD\	Receive signal inverted	
3	TXD	Transmit signal	
4	Termination	Termination	
5	Termination	Termination	
6	TXD\	Transmit signal inverted	
7	Termination	Termination	
8	Termination	Termination	
Diagnostic LEDs			
LED	Color	Status	Description
LNK	Green	On	The link to the remote station is established.
ACT	Orange	On	No Ethernet activity is taking place on the bus.
		Blinking	The link to the remote station is established, and Ethernet activity is taking place on the bus.

## Danger!

External circuits connected to the device must be electrically isolated from the low voltage mains or from lethal voltages using reinforced or double insulation and must meet the requirements for SELV/ PELV circuits.

<sup>3)</sup> The functionality for switching on the terminating resistor using software is available with Automation Studio 4.3.1 and later as well as Automation Runtime 4.31 and later.



### 3.8.3 USB interfaces

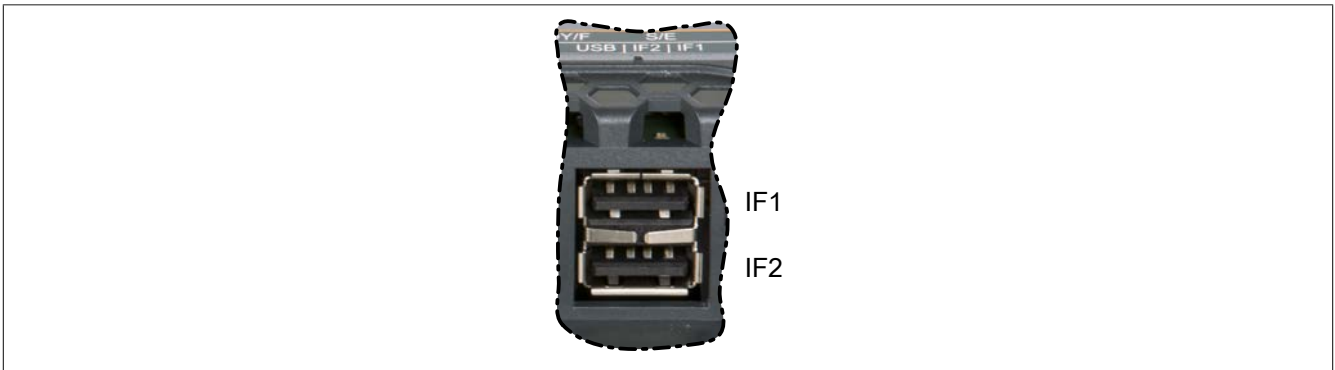

The Power Panel is equipped with a USB 2.0 host controller with 2 USB interfaces.

USB interface	
Transfer rate	Low speed (1.5 Mbit/s), full speed (12 Mbit/s), high speed (480 Mbit/s)
Power supply	Max. 0.49 A per interface <sup>1)</sup>

1) Each USB interface is protected by a maintenance-free "USB current-limiting switch" (max. 0.49 A per interface).

## Important!

### Possible damage to USB interfaces or USB devices!

- **Peripheral USB devices can be connected to the USB interfaces. Due to the large number of USB devices available on the market, B&R cannot guarantee their functionality. Functionality is ensured when using the USB devices available from B&R.**
- **Because of general PC specifications these USB interfaces should be handled with extreme care with regard to EMC, location of cables, etc.**

### 3.8.4 Power supply

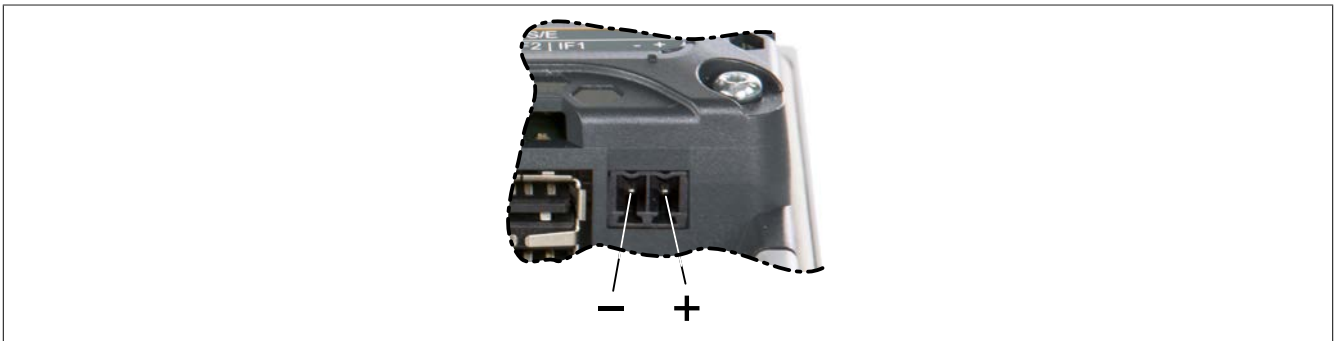

The pinout for the power supply is listed in the following table and printed on the back of the Power Panel. The Power Panel has reverse polarity protection that prevents the supply voltage from being connected incorrectly and damaging the device.

Terminal	Assignment	Explanation
1	+	24 VDC
2	-	GND

Required accessories	
0TB6102.2010-01	Accessory terminal block, 2-pin (3.81), screw clamp terminal block 1.5 mm <sup>2</sup>
0TB6102.2110-01	Accessory terminal block, 2-pin (3.81), cage clamp terminal block 1.5 mm <sup>2</sup>

The supply voltage is protected internally by a soldered fuse (see technical data) against overload. The device must be sent to B&R for repairs if the fuse is destroyed in the event of error (fuse replacement).

## **Danger!**

**This device is only permitted to be supplied with protective extra-low voltage (PELV).**

**Protective earth (grounding clip on the device) and the GND connection of the power supply are connected internally in the Power Panel.**

## **Important!**

**The ground connection of the device must be low impedance and connected to ground (e.g. grounding rail in the control cabinet) using a short path.**

## 4 Commissioning

### 4.1 Installation

#### Important!

##### Possible damage to device!

- Commissioning and maintenance work is only permitted to be performed when the power is switched off. The power cable must also be disconnected from the power supply and device.
  - Do not use force! Handle all the modules and components carefully.
  - All covers, components, accessories, hardware and cables must be installed or connected before the device can be connected to the power supply and switched on.
  - Observe the ESD notes (see "[Protection against electrostatic discharge](#)" on page 6).
- The environmental conditions must be observed.
  - When installed in a closed housing, enough space must be available for air to circulate sufficiently.
  - The device must be installed on a flat, clean and burr-free surface.
  - Ventilation holes are not permitted to be covered.
  - You must observe the permissible mounting orientations when installing the device.
  - When connecting cables, the bend radius must be taken into account.
  - The device must be installed such that viewing is optimized for the user.

Only 2 screws are needed in order to adhere to the mechanical properties. For this reason, the cover of the Power Panel is installed using 2 screws when delivered.

Some devices have unused drill holes that can be used for additional installation purposes (e.g. top-hat rail installation).



#### 4.1.1 Requirements for the cables used

#### Important!

In order to comply with the UL certification, use copper cables that are designed for operating temperature of  $>70\text{ }^{\circ}\text{C}$ .

### 4.1.2 Installation cutout requirements

When installing the Power Panel, it is important to ensure that the surface and wall thickness of the installation cutout meet the following conditions:

Properties of the installation cutout	Value
Permissible deviation from the evenness <b>Note:</b> This condition must also be met with a built-in device.	≤0.5 mm
Permitted surface roughness in the area of the seal	≤120 μm (R z 120)
Min. wall thickness	2 mm
Max. wall thickness	6 mm

#### Important!

The degree of protection of the device (see technical data) can only be maintained if the device is installed in an appropriate housing with at least the same degree of protection per the above requirements.

#### Important!

The device finally has to be built into a safety enclosure, which has adequate rigidity (according to UL61010-1 and UL61010-2-201).

### 4.1.3 Mounting with retaining clips

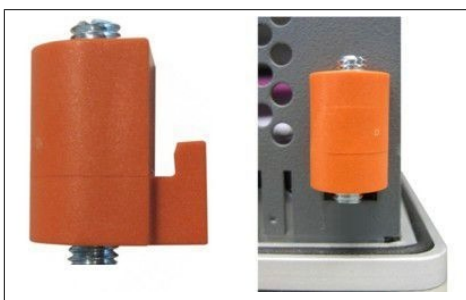

Figure: Retaining clip

The retaining clips are designed for a certain thickness of the material to be clamped (max. 6 mm, min. 2 mm).

A large flat-blade screwdriver is needed to tighten and remove the screws.

Devices must be installed on a flat, clean and burr-free surface; tightening screws on an uneven area can result in damage to the display or the ingress of dust and water.

See also "Installation cutout requirements" on page 36.

#### Procedure

1. Insert the device into the front of the prepared, burr-free and flat installation cutout. For the dimensions of the installation cutout, see section "Dimensions" for the individual devices.
2. Install the retaining clips on the device. To do this, insert the clips into the openings on the sides of the device (indicated by the orange circles). The number of openings may vary depending on the size of the device.

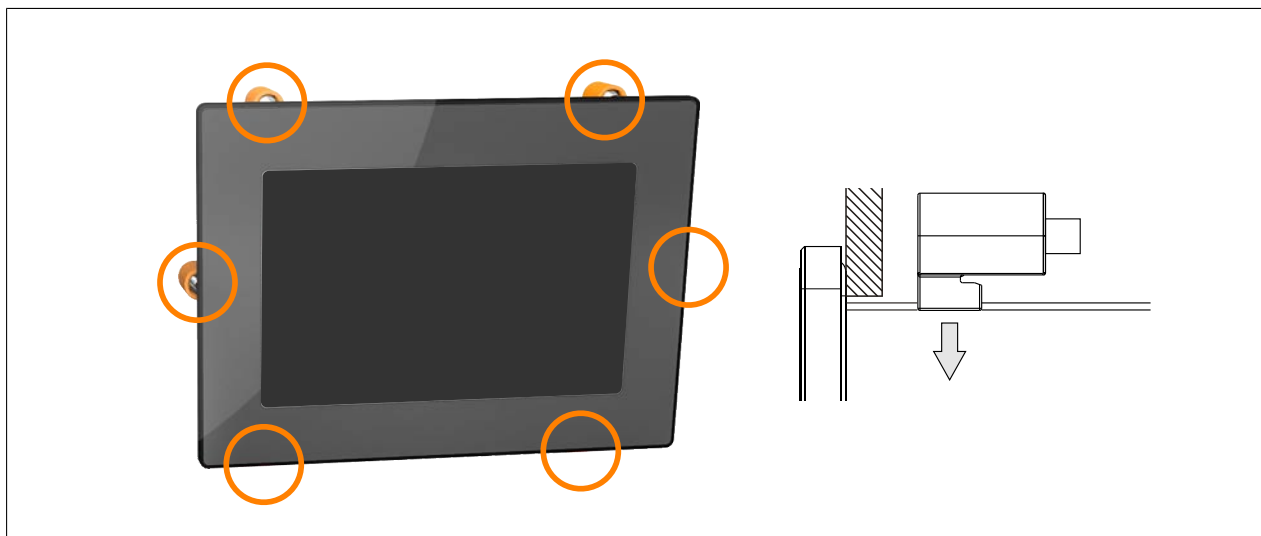

3. Slide the retaining clips all the way to the back of the openings.

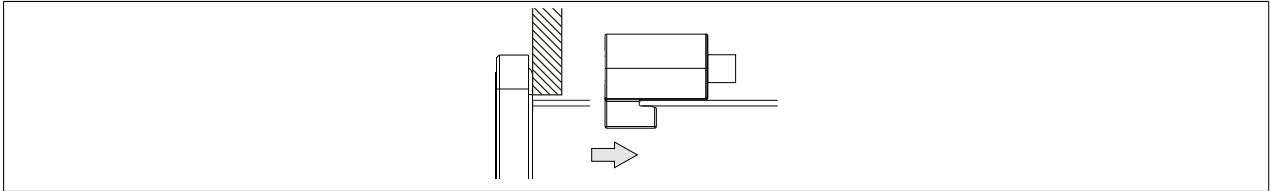

Figure: Sliding the retaining clips back

4. Now secure the retaining clips to the wall or control cabinet by tightening the screws with a flat-blade screwdriver.

Tightening torque: 0.4 Nm

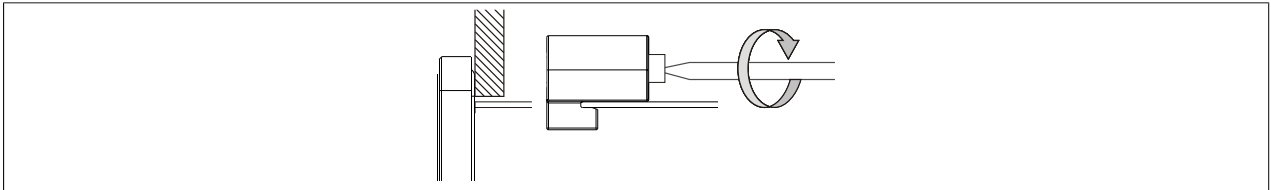

Figure: Securing the retaining clips

#### 4.1.4 Installation instructions

The Power Panel must be mounted using the retaining clips included in delivery (tightening torque: 0.4 Nm).

In order to ensure sufficient air circulation, the specified clearance values must be observed above, below, to the side and behind the Power Panel. The minimum specified spacing is indicated in the following schematic diagrams. This applies to all Power Panel variants.

##### Air circulation - Rear view

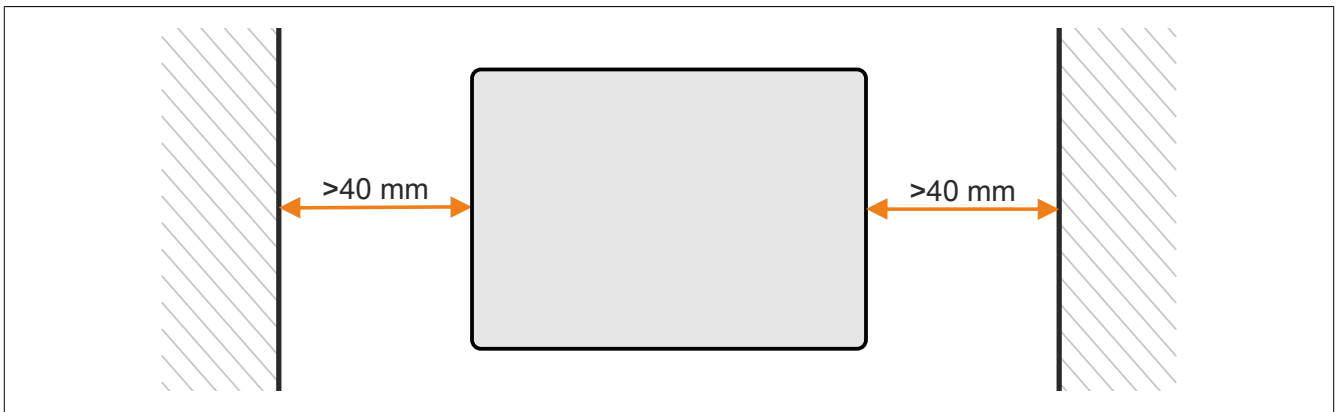

**Air circulation - Side view**

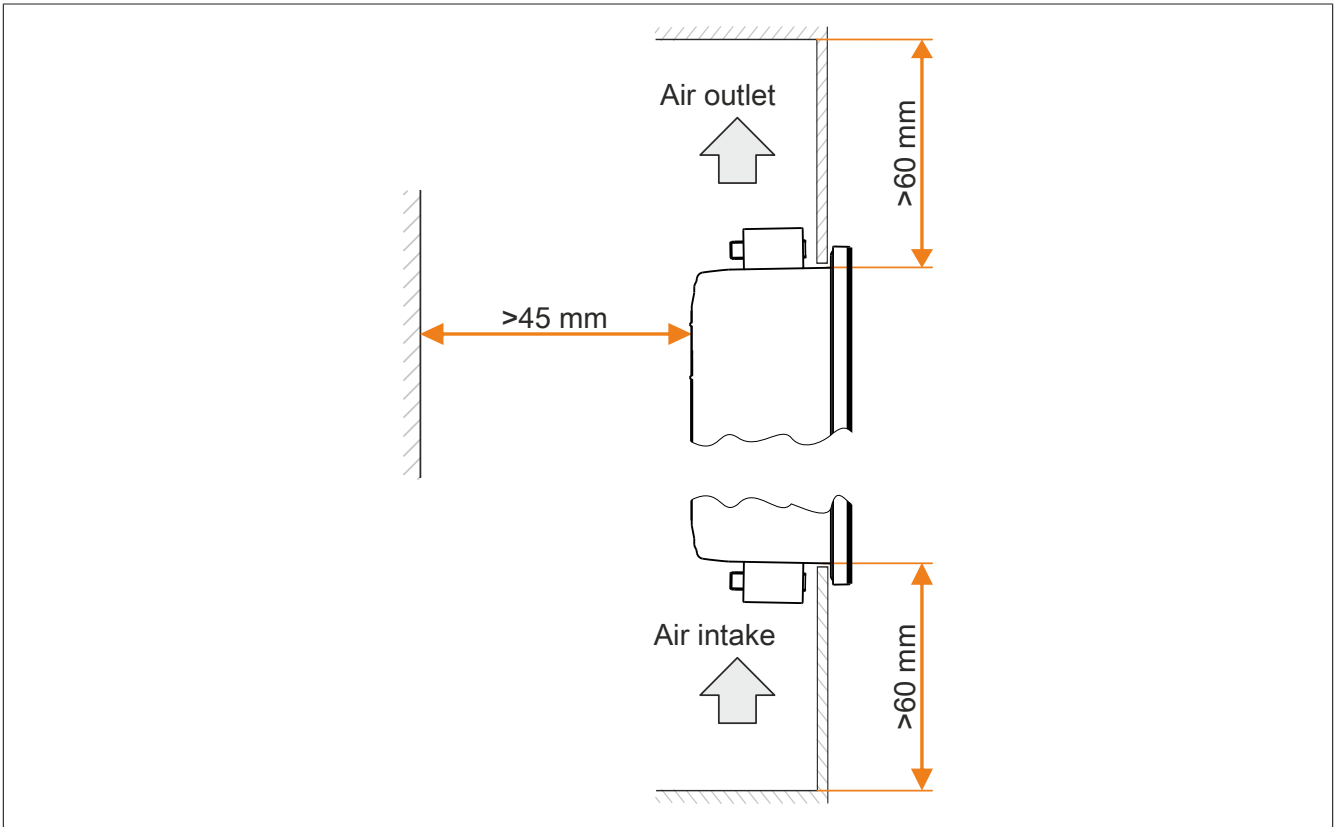

**Information:**

The specified air circulation clearance values are based on worst-case operation at the maximum specified ambient temperature (see "Temperature values" in chapter "Technical data").

**Mounting shield attachment plate for 4.3" Power Panel**

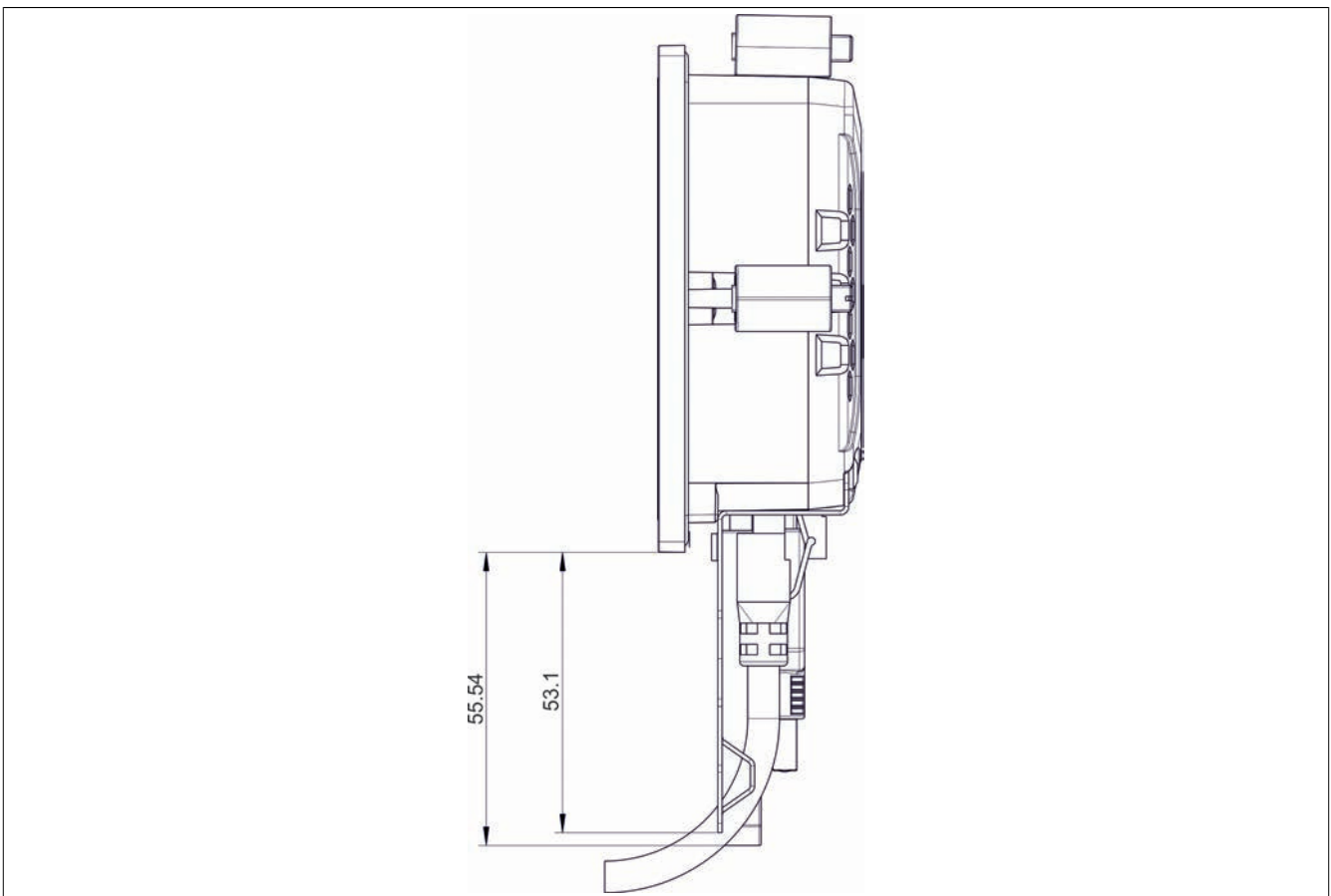

### 4.1.5 Mounting orientations

The following diagram shows the approved mounting orientations for the Power Panel. The mounting orientations apply to all Power Panel variants.

#### Caution!

For the maximum permissible ambient temperature, see the technical data for the respective Power Panel.

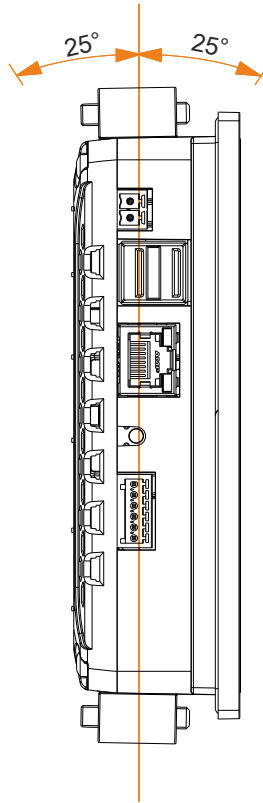

## 4.1.6 Grounding

### Danger!

This device is only permitted to be supplied with protective extra-low voltage (PELV).

Protective earth (grounding clip on the device) and the GND connection of the power supply are connected internally in the Power Panel.

Disturbances are discharged effectively via a grounding clip. The cable shields (e.g. Ethernet) are discharged via the grounding plate. For additional information about electromagnetic compatibility, see the **INSTALLATIONS / EMC GUIDE** user's manual (MAEMV-ENG on the B&R website [www.br-automation.com](http://www.br-automation.com)).

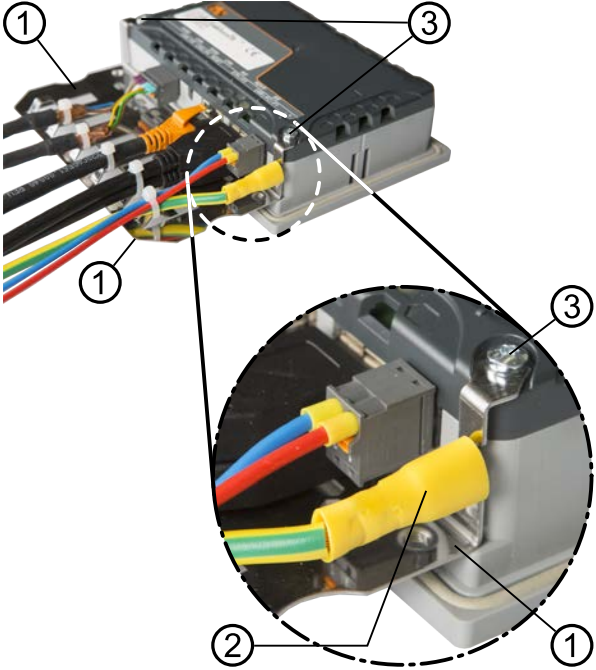
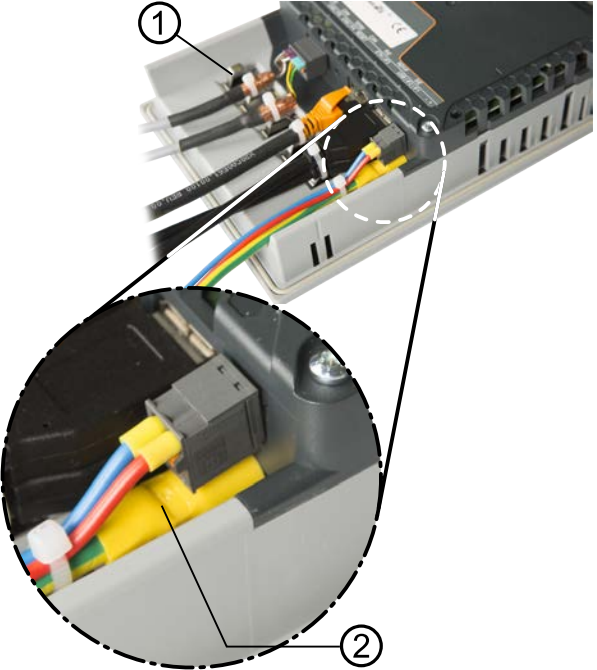
Power Panel - 4.3"	Power Panel - 7.0"
	
<ol style="list-style-type: none"> <li>1 Grounding plate (included in delivery)</li> <li>2 Grounding connection to the grounding clip on the grounding plate</li> <li>3 The grounding plate is connected directly to the device with the available screws.</li> </ol> <p>See <a href="#">Mounting shield attachment plate for 4.3" Power Panel</a>, page 38</p>	<ol style="list-style-type: none"> <li>1 Grounding plate (built into the device)</li> <li>2 Grounding connection to the grounding clip on the grounding plate</li> </ol>



## Grounding in the control cabinet

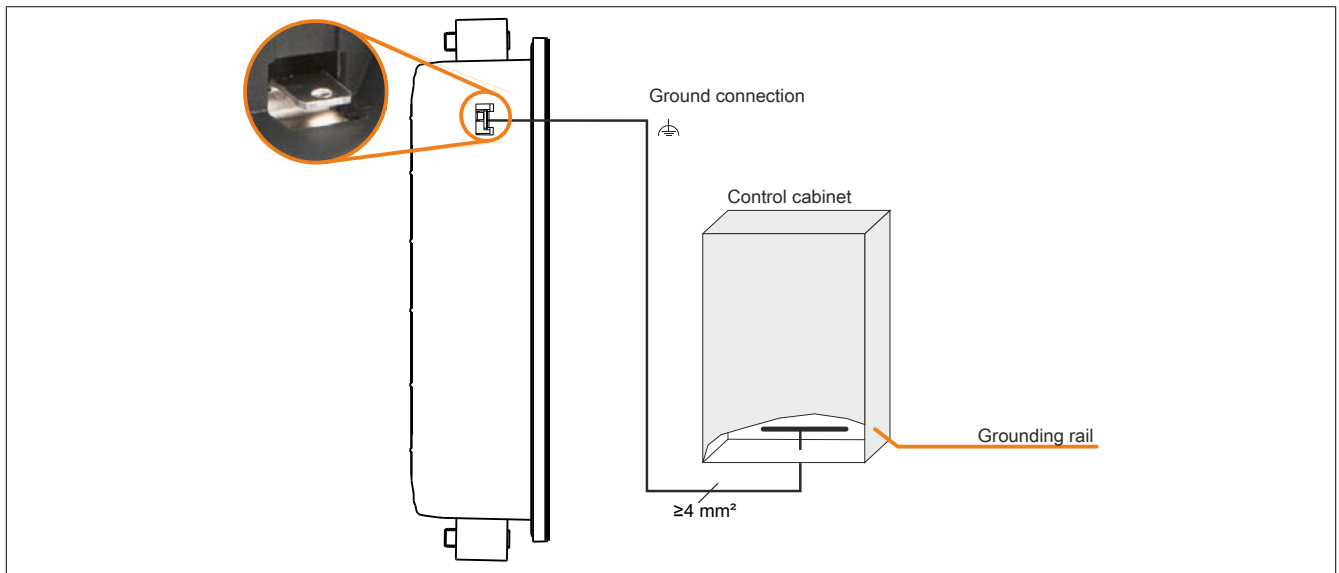

Figure: Grounding in the control cabinet

### Important!

The ground connection of the device must be low impedance and connected to ground (e.g. grounding rail in the control cabinet) using a short path.

### Securing the conductor lines to the grounding plate

#### 1 Ground conductor

The connection to ground potential must be as short as possible and sufficiently strong ( $\geq 4 \text{ mm}^2$ ) over the intended spade terminal (Faston 6.3 mm).

#### 2 Shielded lines

A central ground connection is available to effectively deflect interference. All cable shields must be connected to ground with good conductivity using a cable tie on the grounding plate or some other method.

#### 3 Unshielded lines

All unshielded lines must be relieved of tension by using a cable tie to tie them to the grounding plate.

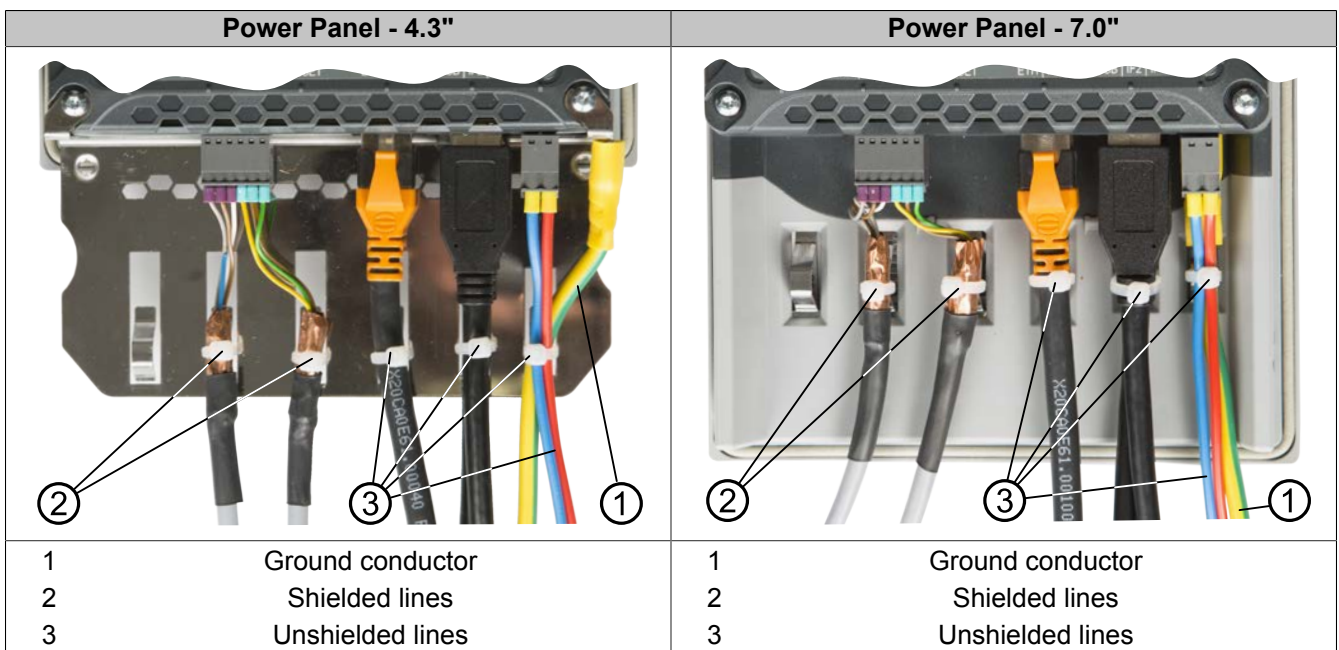

## 4.2 Commissioning

The Power Panel is delivered with Boot AR. This is an operating system with a limited range of functions but that provides all functions necessary for an online connection between Automation Studio and the Power Panel.

In order to put the Power Panel into service, a full version of Automation Runtime must be transferred to the Power Panel. The following options are available for this:

- [Transferring Automation Runtime over a network with a DHCP server](#)
- [Transferring Automation Runtime over a network without a DHCP server](#)
- [USB flash drive - remote install structure](#)

### Transferring Automation Runtime over a network with a DHCP server

See Automation Help:

⇒ Real-time operating system ▶ Target systems ▶ Target systems - SG4 ▶ Automation Runtime remote install

### Transferring Automation Runtime over a network without a DHCP server

- ▶ Connect the Power Panel to the Ethernet network.
- ▶ Switch on the Power Panel.
- ▶ Create a new project with the Power Panel in Automation Studio.
- ▶ In a network without a DHCP server, an IP address must be assigned to the Power Panel in order for an online connection between Automation Studio and the Power Panel to be established:
  - Menu option **Online / Settings** opens connection window "Online settings".
  - The target system search is started in this window with menu option **View / Online settings / Browse**.
  - The list of target systems found also includes the Power Panel. Since an IP address has not yet been assigned to the Power Panel, address 0.0.0.0 is displayed.
  - Command **Set IP parameters** (Power Panel shortcut menu) opens the dialog box where all required network configurations can be made temporarily (they should be identical to the settings defined in the project).

#### Information:

The data required for manual network configuration can be obtained from the network or system administrator.

- ▶ Rebuild the project in Automation Studio with menu option **Project / Rebuild configuration**.
- ▶ The connection must first be enabled in order to transfer Automation Runtime to the Power Panel. This is done using option **Connect** from the Power Panel's shortcut menu.
- ▶ Automation Runtime can then be transferred to the Power Panel with the following menu option:

AS version <4.3.3	Online / Services / Transfer Automation Runtime
AS V4.3.3 or later	Project / Project installation / Transfer Automation Runtime

- ✓ Then follow the instructions provided by Automation Studio.

#### Information:

Memory is erased first during this procedure; Automation Runtime is then transferred and after 3 automatic restarts the Power Panel is in mode RUN.

### USB flash drive - remote install structure

See details in the Runtime Utility Center (RUC) documentation in Automation Help.

## 4.3 Operating the Power Panel

The following input methods can be used individually or together to operate the Power Panel:

- Touch screen
- USB keyboard (configurable in Automation Studio)

### 4.3.1 Touch screen

The touch screen ① of the Power Panel juts out over the display on all four sides by about 1 cm:

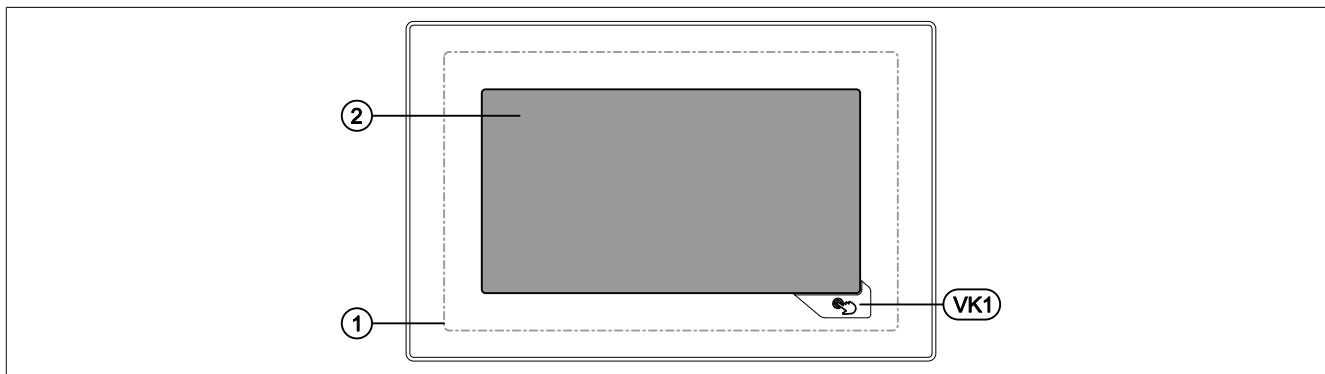

Touching the touch screen ② (corresponds to the display) and the Hand button (VK1) triggers commands in the application.

Because the analog resistive touch screen is not capable of multi-touch, touching multiple positions simultaneously generates an average value. This averaged position value is evaluated by the application. Because the entire touch screen ① is bigger than the display itself, it may occur that multiple touches (also outside of the display area) can lead to a command being triggered unintentionally. This can happen when the Power Panel is held in your hands.

#### Defined touch keys

The following touch keys (virtual keys) are predefined if the Visual Components object is used for designing the HMI application in Automation Studio:

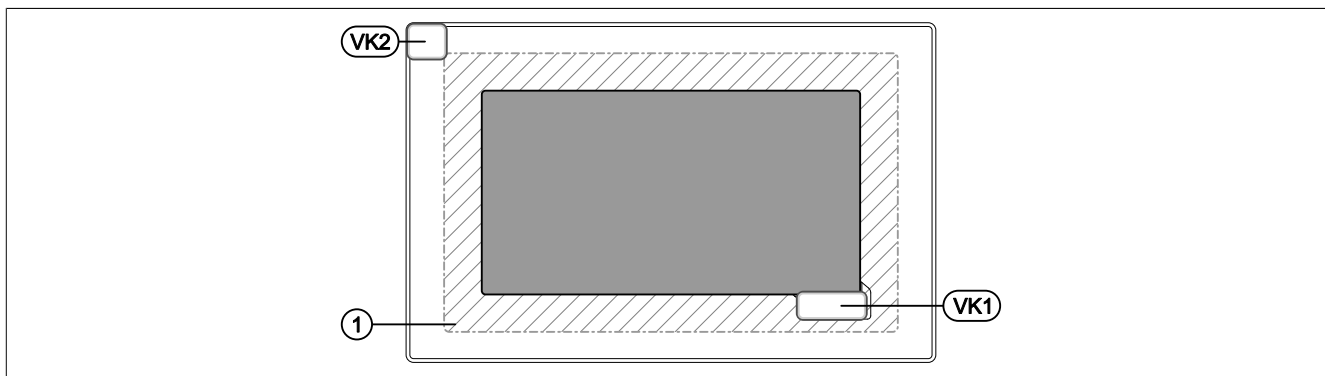

In addition to the Hand button (VK1 virtual key), a further VK2 virtual key is available, which represents the touch-screen ① outside of the display area (hatched area). With this key, a touch outside of the display area can be recognized by the application. The application can warn the user of faulty operation with a corresponding message.

#### Version dependencies

Virtual key VK2 is available **starting with** Automation Runtime A4.41 and **starting with** the following version of the hardware upgrade:

4.3" variants	Model number	4PPC30.043F-21 B	4PPC30.043F-22B	4PPC30.043F-23 B
	Initial hardware upgrade	1.1.0.0	1.0.0.0	1.0.0.0
7.0" variants	Model number	4PPC30.0702-21B	4PPC30.0702-22B	4PPC30.0702-23B
	Initial hardware upgrade	1.1.0.0	1.0.0.0	1.0.0.0
10.1" variants	Model number	4PPC30.101G-21B	4PPC30.101G-22B	4PPC30.101G-23B
	Initial hardware upgrade	1.0.0.0	1.0.0.0	1.0.0.0

### 4.3.2 Touch screen calibration

B&R touch screen devices are equipped with a touch controller that supports hardware calibration. These devices come already pre-calibrated from the factory. This is an advantageous feature when replacing devices with an identical model of the same type since it avoids having to recalibrate the new device. Nevertheless, calibrating the device is recommended in order to achieve the best results and to adapt the touch screen to the user's preferences.

During the calibration process, the specified point must be pressed four times in row within a certain time frame.

An error message is displayed if calibration is not performed properly.

#### Information:

**A stylus pen (e.g. 9A0013.01) is recommended for touch screen calibration.**

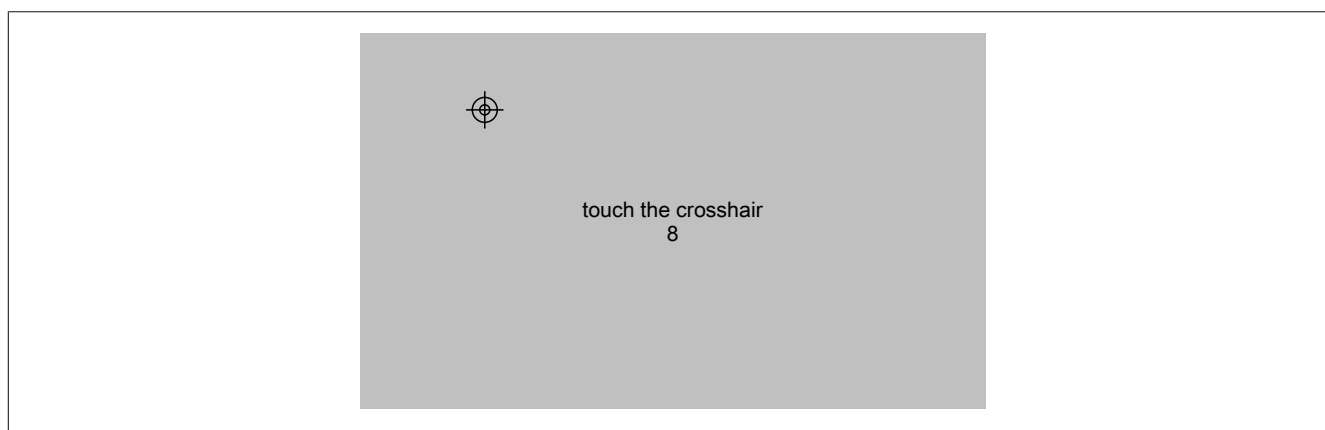

Figure: Touch screen calibration

#### Touch screen calibration from the application using Visual Components.

Touch screen calibration is started in the application. The several options available to the user are described in Automation Help in section "Visual Components". See the following keywords:

- Data points *CalibrationDatapoint* and *CalibrationStateDatapoint*
- Key action *CalibrateTouch*

### 4.3.3 Set brightness with the application

Function `VA_SetBrightness` from library `VISAPI` sets the brightness of the display (see library description in Automation Help).

### 4.3.4 Screen rotation

The angle of rotation of the Power Panel can be set to  $0^\circ$  or  $180^\circ$  in the Automation Studio device configuration. This setting allows an HMI application to be rotated  $180^\circ$ .

The orientation of the HMI application is defined in the visualization object in Automation Studio.

#### Information:

**Due to the mechanical construction of the 4.3" variants, the standard mounting orientation of the Power Panel (Hand button at the bottom right) corresponds to an  $180^\circ$  angle of rotation of the HMI application.**

## 5 Maintenance

---

### 5.1 Cleaning

#### **Danger!**

**Power Panel devices are only permitted to be cleaned while switched off in order to prevent unintended functions from being triggered when handling the touch screen or pressing keys.**

Power Panel devices should be cleaned with a moist cloth. The cloth should be moistened with water and detergent, a screen cleaning agent or alcohol (ethanol). The cleaning agent should be applied to the cloth beforehand, not sprayed directly on the Power Panel! Never use aggressive solvents, chemicals, scouring agents, pressurized air or steam-jet air ejectors.

#### **Important!**

**Cleaning the label on the back of the unit is only permitted with a dry cloth. This ensures readability of the thermal print during the service life of the device.**

#### **Information:**

**The display with the touch screen should be cleaned at regular intervals.**

## 5.2 User tips for increasing the service life of the display or touch screen

### Pixel errors

#### Information:

Displays may contain defective pixels (pixel errors) that result from the manufacturing process. They are not grounds for initiating a complaint or warranty claim.

### 5.2.1 Service life

The maximum service life of the analog resistive touch screen is 10 million actuations.

The following diagram describes the force required to activate the touch screen over the course of its service life. The requirements are the same as those for specifying a maximum of 10 million operations.

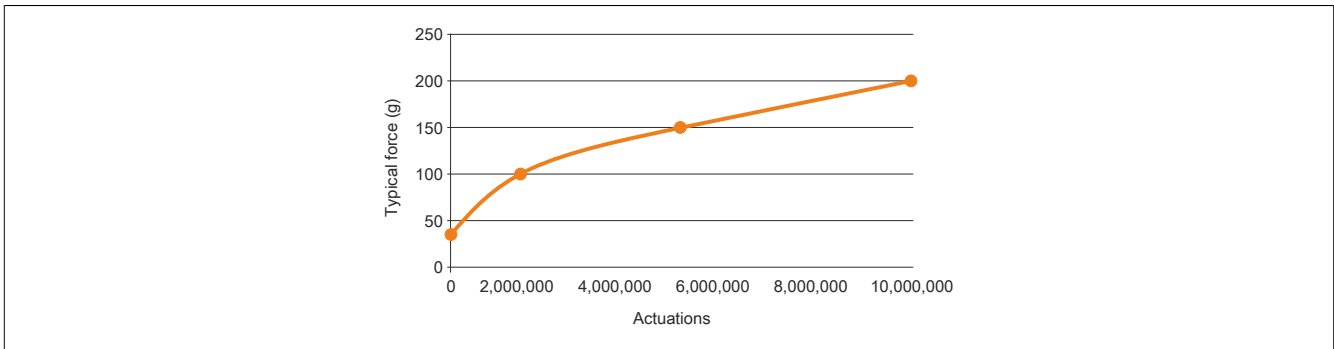

### 5.2.2 Backlight

The service life of the backlight is specified by its "half-brightness time". An operating time of 50,000 would mean that the display would still retain 50% of its brightness after this time.

#### How can the service life of backlights be extended?

- Setting the display brightness to the lowest value that is still comfortable for the eyes
- Using dark images
- Reducing the brightness by 50% can increase the half-brightness time by approximately 50%.

### 5.2.3 Image persistence

Image persistence refers to the "burning in" of a static image on a display after being displayed for a prolonged period of time. This not only occurs with static images, however. Image persistence is also referred to in the technical literature as burn-in effect, image retention, memory effect, memory sticking or ghost image.

There are basically 2 types:

- Area type: This type is characterized by a dark gray image. The effect disappears if the display is switched off for a long period of time.
- Line type: Can result in permanent damage.

#### What causes image persistence?

- Static images
- No screensaver
- Sharp transitions in contrast (e.g. black/white)
- High ambient temperatures
- Operation outside of specifications

**How can image persistence be reduced?**

- Constantly switching between static and dynamic images
- Avoiding excessive brightness differences between foreground and background elements
- Using colors with similar brightness
- Using complementary colors in consecutive images
- Using screensavers

## 6 Accessories

---

### 6.1 Overview

Model number	Product	Page
<b>Cage clamp terminal block</b>		
0TB6102.2110-01	Accessory 2-pin cage clamp terminal block (3.81) for power supply	49
0TB5106.2110-01	Accessory 6-pin cage clamp terminal block (2.5) for CAN bus	50
<b>Screw clamp terminal block</b>		
0TB6102.2010-01	Accessory 2-pin screw clamp terminal block (3.81) for power supply	49
<b>USB accessories</b>		
5MMUSB.2048-01	USB 2.0 flash drive, 2048 MB, B&R	50
5MMUSB.4096-01	USB 2.0 flash drive, 4096 MB, B&R	50
<b>Other accessories</b>		
9A0013.01	Stylus pen for resistive touch screen	



## 6.2 TB6102 2-pin power supply connector

This 1-row 2-pin terminal block is used to connect the power supply.

### 6.2.1 Order data

Model number	Short description
	<b>Terminal blocks</b>
OTB6102.2010-01	Accessory terminal block, 2-pin (3.81), screw clamp terminal block 1.5 mm <sup>2</sup>
OTB6102.2110-01	Accessory terminal block, 2-pin (3.81), cage clamp terminal block 1.5 mm <sup>2</sup>

Table 10: OTB6102.2010-01, OTB6102.2110-01 - Order data

### 6.2.2 Technical data

#### Information:

The following specifications, properties and limit values apply only to this accessory and may deviate from those that apply to the complete system. The data specifications for the complete system take precedence over those of individual components.

The technical data in this manual is current as of its creation/publication. We reserve the right to make changes.

Model number	OTB6102.2010-01	OTB6102.2110-01
<b>Terminal block</b>		
Number of pins	2 (female)	
Type of terminal block	Screw clamp terminal block	Cage clamp terminal block
Cable type	Only copper wires (no aluminum wires!)	
Spacing	3.81 mm	
Connection cross section		
AWG wire	28 to 16	
Wire end sleeves with plastic covering	0.25 to 0.5 mm <sup>2</sup>	
With wire end sleeves	0.25 to 1.5 mm <sup>2</sup>	
Flexible	0.14 to 1.5 mm <sup>2</sup>	
Inflexible	0.14 to 1.5 mm <sup>2</sup>	
Tightening torque	0.22 to 0.25 Nm	-
<b>Electrical characteristics</b>		
Nominal voltage	300 V	
Nominal current <sup>1)</sup>	8 A	

Table 11: OTB6102.2010-01, OTB6102.2110-01 - Technical data

1) The limit data for each Power Panel must be taken into consideration.

## 6.3 0TB5106.2110-01 6-pin cage clamp terminal block

The 1-row 6-pin terminal block is needed for the 2 bus interfaces.

### 6.3.1 Order data

Model number	Short description	Figure
0TB5106.2110-01	Accessory terminal block, 6-pin (2.5), cage clamp terminal block 0.5 mm <sup>2</sup>	

Table 12: 0TB5106.2110-01 - Order data

### 6.3.2 Technical data

#### Information:

The following characteristics, features and limit values only apply to this accessory and can deviate from those specified for the complete system. The data specifications for the complete system take precedence over those of individual components.

The technical data in this manual is current as of its creation/publication. We reserve the right to make changes.

Model number	0TB5106.2110-01
<b>Terminal block</b>	
Number of pins	6
Type of terminal block	Cage clamp terminal block
Cable type	Only copper wires (no aluminum wires!)
Spacing	2.5 mm
Connection cross section	
AWG wire	26 to 20
With wire end sleeves	0.25 to 0.5 mm <sup>2</sup>
Flexible	0.14 to 0.5 mm <sup>2</sup>
Inflexible	0.14 to 0.5 mm <sup>2</sup>
<b>Electrical characteristics</b>	
Nominal voltage	125 V
Nominal current <sup>1)</sup>	4 A

Table 13: 0TB5106.2110-01 - Technical data

1) Take the respective limit data for the I/O modules into consideration!

## 6.4 Data storage devices

For technical data and additional information about data storage devices, see the corresponding documentation. This can be located and downloaded by searching for the data storage device's model number at [www.br-automation.com](http://www.br-automation.com).

## 7 International and national certifications

Power Panel devices meet the requirements of the listed certifications and their relevant standards. We are committed to ensuring the reliability of our products in industrial environments.

### Information:

Certifications applicable to the respective Power Panel are available at the following locations:

- Chapter "Device description" in section "Technical data" for the individual products.
- On the website [www.br-automation.com](http://www.br-automation.com) in section "Technical data" for the individual products (possible to search using model number).
- On the product label (see Power Panel housing).

Changes and new certifications are promptly made available in electronic form on the B&R website at [www.br-automation.com](http://www.br-automation.com).

### 7.1 Overview of certifications

Mark	Explanation	Certificate authority	Region
	CE marking	Notified bodies	Europe (EU)
	Underwriters Laboratories Inc. (UL) (certification for Canada and USA)	UL	Canada USA

## 7.2 EU directives and standards (CE)

### CE markings



The respective product complies with all applicable EU directives and relevant harmonized standards.

Certification of these products is performed in cooperation with accredited testing laboratories.

### Europe (EU)

#### EMC Directive 2014/30/EU

All devices satisfy the protection requirements of the "EMC directive" and are designed for industrial use:

Applicable standards from this directive:

EN 61131-2	Programmable logic controllers - Part 2: Guidance for inspection and routine testing
EN 61000-6-2	Electromagnetic compatibility (EMC) - Part 6-2: Generic standards - Immunity standard for industrial environments
EN 61000-6-4	Electromagnetic compatibility (EMC) - Part 6-4: Generic standards - Emissions standard for industrial environments

The corresponding declaration of conformity is available for download from the B&R website. For information about the versions of applicable standards, see the declaration of conformity.



#### Declaration of conformity

[Website > Downloads > Certificates > Declarations of conformity > Declaration of conformity HMI IPC](#)

## 7.2.1 Overview of standards

Standard	Description
EN 55011 (CISPR 11)	Industrial, scientific and medical equipment - Radio frequency disturbance characteristics - Limits and methods of measurement
EN 55016-2-1 (CISPR 16-2-1)	Specification for radio disturbance and immunity measuring apparatus and methods - Part 2-1: Methods of measurement of disturbances and immunity - Conducted disturbance measurements
EN 55016-2-3 (CISPR 16-2-3)	Specification for radio disturbance and immunity measuring apparatus and methods - Part 2-3: Methods of measurement of disturbances and immunity - Radiated disturbance measurements
EN 55022 (CISPR 22)	Information technology equipment - Radio disturbance characteristics - Limits and methods of measurement
EN 60068-2-6	Environmental testing - Part 2-6: Procedures - Test Fc: Vibration (sinusoidal)
EN 60068-2-27	Environmental testing - Part 2-27: Test procedure - Test Ea and guidance: Shock
EN 60068-2-31 <sup>1)</sup>	Environmental testing - Part 2-31: Test procedure - Test Ec: Rough handling shocks, mainly for devices
EN 60529	Degrees of protection provided by enclosures (IP code)
EN 60664-1	Insulation coordination for equipment within low-voltage systems - Part 1: Principles, requirements and tests
EN 60721-3-2	Classification of environmental conditions - Part 3: Classification of groups of environmental parameters and their severities - Section 2: Transport
EN 60721-3-3	Classification of environmental conditions - Part 3: Classification of groups of environmental parameters and their severities - Section 3: Stationary use at weather-protected locations
EN 61000-4-2	Electromagnetic compatibility (EMC) - Part 4-2: Testing and measurement techniques - Electrostatic discharge immunity test
EN 61000-4-3	Electromagnetic compatibility (EMC) - Part 4-3: Testing and measurement techniques - Radiated, radio-frequency, electromagnetic field immunity test
EN 61000-4-4	Electromagnetic compatibility (EMC) - Part 4-4: Testing and measurement techniques - Electrical fast transient/burst immunity test
EN 61000-4-5	Electromagnetic compatibility (EMC) - Part 4-5: Testing and measuring techniques - Surge immunity test
EN 61000-4-6	Electromagnetic compatibility (EMC) - Part 4-6: Testing and measurement techniques - Immunity to conducted disturbances, induced by radio-frequency fields
EN 61000-4-8	Electromagnetic compatibility (EMC) - Part 4-8: Testing and measuring techniques - Power frequency magnetic field immunity test
EN 61000-4-11	Electromagnetic compatibility (EMC) - Part 4-11: Testing and measurement techniques - Immunity tests for voltage dips, short interruptions and voltage variations
EN 61000-4-29	Electromagnetic compatibility (EMC) - Part 4-29: Testing and measurement techniques - Voltage dips, short interruptions and voltage variations on DC input power port immunity tests
EN 61000-6-2	Electromagnetic compatibility (EMC) - Part 6-2: Generic standards - Immunity standard for industrial environments
EN 61000-6-4	Electromagnetic compatibility (EMC) - Part 6-4: Generic standards - Emission standard for industrial environments
EN 61131-2	Programmable logic controllers - Part 2: Guidance for inspection and routine testing

1) Replacement for EN 60068-2-32

## 7.2.2 Requirements for immunity to disturbances

Immunity	Testing performed per standard:	Requirements per standard:	
		EN 61131-2 <sup>1)</sup>	EN 61000-6-2 <sup>2)</sup>
Electrostatic discharge (ESD)	EN 61000-4-2	✓	✓
High-frequency electromagnetic fields (HF field)	EN 61000-4-3	✓	✓
High-speed transient electrical disturbances (Burst)	EN 61000-4-4	✓	✓
Surge voltages (Surge)	EN 61000-4-5	✓	✓
Conducted disturbances	EN 61000-4-6	✓	✓
Magnetic fields with electrical frequencies	EN 61000-4-8	✓	✓
Voltage dips (AC) Short-term interruptions (AC) Voltage fluctuations (AC)	EN 61000-4-11	✓	✓
Short-term interruptions (DC) Voltage fluctuations (DC)	EN 61000-4-29	✓	-

- 1) EN 61131-2: Product standard - Programmable logic controllers  
2) EN 61000-6-2: Generic standard - Immunity for industrial environments

### Criteria to prove the performance of a PLC system against EMC disturbances

Criteria	During test	After test
<b>A</b>	The PLC system shall continue to operate as intended. No loss of function or performance.	The PLC system shall continue to operate as intended.
<b>B</b>	Degradation of performance accepted. The operating mode is not permitted to change. Irreversible loss of stored data is not permitted.	The PLC system shall continue to operate as intended. Temporary degradation of performance must be self-recoverable.
<b>C</b>	Loss of functions accepted, but no destruction of hardware or software (program or data).	The PLC system shall continue to operate as intended automatically, after manual restart or power off / power on.
<b>D</b>	Degradation or failure of functionality that can no longer be restored.	PLC system permanently damaged or destroyed.

### Electrostatic discharge (ESD)

Testing performed per standard: EN 61000-4-2	Requirements per standard: EN 61131-2 / Zone B	Requirements per standard: EN 61000-6-2
Contact discharge (CD) to conductive accessible parts		±4 kV Criteria B
Air discharge (AD) to insulating external parts		±8 kV Criteria B

### High-frequency electromagnetic fields (HF field)

Testing performed per standard: EN 61000-4-3	Requirements per standard: EN 61131-2 / Zone B	Requirements per standard: EN 61000-6-2
Housing, completely wired		80 MHz to 1 GHz, 10 V/m 1.4 to 2 GHz, 3 V/m 2 to 2.7 GHz, 1 V/m Criteria A

### High-speed transient electrical disturbances (Burst)

Testing performed per standard: EN 61000-4-4	Requirements per standard: EN 61131-2 / Zone B	Requirements per standard: EN 61000-6-2
AC power inputs		±2 kV / 5 kHz Criteria B
AC power outputs	±2 kV / 5 kHz <sup>1)</sup> Criteria B	±2 kV / 5 kHz Criteria B
Other AC I/O	±2 kV / 5 kHz <sup>1)</sup> Criteria B	-
DC mains inputs/outputs		±2 kV / 5 kHz <sup>1)</sup> Criteria B
Other I/Os and interfaces		±1 kV / 5 kHz <sup>1)</sup> Criteria B

- 1) Only for connections with a permitted line length greater than 3 m.

## Surge voltages (Surge)

Testing performed per standard: EN 61000-4-5	Requirements per standard: EN 61131-2 / Zone B	Requirements per standard: EN 61000-6-2
AC mains inputs/outputs Line / line		±1 kV Criteria B
AC mains inputs/outputs Line / ground		±2 kV Criteria B
DC mains inputs/outputs Line / line	±0.5 kV <sup>1)</sup> Criteria B	±0.5 kV Criteria B
DC power inputs Line / ground	±0.5 kV <sup>1)</sup> Criteria B	±0.5 kV Criteria B
DC power outputs Line / ground	±0.5 kV <sup>1)</sup> Criteria B	±0.5 kV Criteria B
Signal connections, unshielded Line / ground		±1 kV <sup>1)</sup> Criteria B
All shielded lines Line / ground	±1 kV <sup>1)</sup> Criteria B	-

1) Only for connections with a permitted line length greater than 30 m.

## Conducted disturbances

Testing performed per standard: EN 61000-4-6	Requirements per standard: EN 61131-2 / Zone B	Requirements per standard: EN 61000-6-2
AC mains inputs/outputs		10 V 150 kHz to 80 MHz 80% AM (1 kHz) Criteria A
DC mains inputs/outputs		10 V 150 kHz to 80 MHz 80% AM (1 kHz) Criteria A
Other I/Os and interfaces		10 V <sup>1)</sup> 150 kHz to 80 MHz 80% AM (1 kHz) Criteria A

1) Only for connections with a permitted line length greater than 3 m.

## Magnetic fields with electrical frequencies

Testing performed per standard: EN 61000-4-8	Requirements per standard: EN 61131-2 / Zone B	Requirements per standard: EN 61000-6-2
Housing, completely wired		30 A/m 3 axes (x, y, z) 50/60 Hz <sup>1)</sup> Criteria A

1) Mains frequency per manufacturer data

## Voltage dips

Testing performed per standard: EN 61000-4-11	Requirements per standard: EN 61131-2 / Zone B	Requirements per standard: EN 61000-6-2
AC power inputs		0% residual voltage 250/300 periods (50/60 Hz) <sup>1)</sup> 20 attempts Criteria C
		40% residual voltage 10/12 periods (50/60 Hz) <sup>1)</sup> 20 attempts Criteria C
		70% residual voltage 25/30 periods (50/60 Hz) <sup>1)</sup> 20 attempts Criteria C

1) Mains frequency per manufacturer data

## Short-term interruptions

Testing performed per standard: EN 61000-4-11 / EN 61000-4-29	Requirements per standard: EN 61131-2 / Zone B	Requirements per standard: EN 61000-6-2
AC power inputs	0% residual voltage 0.5 periods (50/60 Hz) <sup>1)</sup> 20 attempts Criteria A	0% residual voltage 1 period (50/60 Hz) <sup>1)</sup> 3 attempts Criteria B
DC power inputs	0% residual voltage ≥10 ms (PS2) <sup>2)</sup> 20 attempts Criteria A	-

1) Mains frequency per manufacturer data

2) Use of a B&R power supply guarantees that these requirements are met.

### Voltage fluctuations

Testing performed per standard: EN 61000-4-11 / EN 61000-4-29	Requirements per standard: EN 61131-2 / Zone B	Requirements per standard: EN 61000-6-2
AC power inputs	-15% / +10% Test duration per 30 minutes Criteria A	-
DC power inputs	-15% / +20% Test duration per 30 minutes Criteria A	-

### 7.2.3 Emission requirements

Phenomenon	Testing performed per standard:	Limit values per standard:	
		EN 61131-2 <sup>1)</sup>	EN 61000-6-4 <sup>2)</sup>
Emissions related to lines	EN 55011 / EN 55022 EN 55016-2-1	✓	✓
Radiated emissions	EN 55011 / EN 55022 EN 55016-2-3	✓	✓

1) EN 61131-2: Product standard - Programmable logic controllers

2) EN 61000-6-4: Generic standards - Emission standard for industrial environments

### Emissions related to lines

Testing performed per standard: EN 55011 / EN 55022 / EN 55016-2-1	Limit values per standard: EN 61131-2 / Zone B	Limit values per standard: EN 61000-6-4
AC mains connection 150 kHz to 30 MHz	150 to 500 kHz 79 dB (µV) quasi-peak value 66 dB (µV) average value	
	500 kHz to 30 MHz 73 dB (µV) quasi-peak value 60 dB (µV) average value	
Telecommunications / network connection 150 kHz to 30 MHz	-	150 to 500 kHz 97 to 87 dB (µV) quasi-peak value 53 to 40 dB (µA) quasi-peak value 84 to 74 dB (µV) average value 40 to 30 dB (µA) average value
	-	500 kHz to 30 MHz 87 dB (µV) quasi-peak value 43 dB (µA) quasi-peak value 74 dB (µV) average value 30 dB (µA) average value

### Radiated emissions

Testing performed per standard: EN 55011 / EN 55022 / EN 55016-2-3	Limit values per standard: EN 61131-2 / Zone B	Limit values per standard: EN 61000-6-4
Electric field / Measured from 10 m 30 MHz to 1 GHz	30 to 230 MHz 40 dB (µV/m) quasi-peak value	
	230 MHz to 1 GHz 47 dB (µV/m) quasi-peak value	
Electric field / Measured from 3 m 1 to 6 GHz <sup>1)</sup>	-	1 to 3 GHz 76 dB (µV/m) peak value 56 dB (µV/m) average value
	-	3 to 6 GHz 80 dB (µV/m) peak value 60 dB (µV/m) average value

1) Depending on highest internal frequency



## 7.2.4 Mechanical conditions

Testing	Testing performed per standard:	Requirements per standard:				
		EN 61131-2 <sup>1)</sup>	EN 60721-3-2 Class 2M1	EN 60721-3-2 Class 2M2	EN 60721-3-2 Class 2M3	EN 60721-3-3 Class 3M4
Vibration (sinusoidal) / Operation	EN 60068-2-6	✓	-	-	-	✓
Shock / Operation	EN 60068-2-27	✓	-	-	-	✓
Vibration (sinusoidal) / Transport (packaged)	EN 60068-2-6	-	✓	✓	✓	-
Shock / Transport (packaged)	EN 60068-2-27	-	✓	✓	-	-
Free fall / Transport (packaged)	EN 60068-2-31 <sup>2)</sup>	✓	✓	-	-	-
Toppling / Transport (packaged)	EN 60068-2-31	-	✓	✓	✓	-

- 1) EN 61131-2: Product standard - Programmable logic controllers  
 2) Replacement for EN 60068-2-32

### Vibration (sinusoidal) / Operation

Testing performed per standard: EN 60068-2-6	Requirements per standard: EN 61131-2		Requirements per standard: EN 60721-3-3 / Class 3M4	
Vibration (sinusoidal) <sup>1)</sup> Operation	Frequency	Amplitude	Frequency	Amplitude
	5 to 8.4 Hz	Deflection 3.5 mm	2 to 9 Hz	Deflection 3 mm
	8.4 to 150 Hz	Acceleration 1 g <sup>2)</sup>	9 to 200 Hz	Acceleration 1 g <sup>2)</sup>
20 sweeps for each axis <sup>3)</sup>				

- 1) Uninterrupted duty with movable frequency in all 3 axes (x, y, z); 1 octave per minute  
 2) 1 g = 10 m/s<sup>2</sup>  
 3) 2 sweeps = 1 frequency cycle ( $f_{min} \rightarrow f_{max} \rightarrow f_{min}$ )

### Shock / Operation

Testing performed per standard: EN 60068-2-27	Requirements per standard: EN 61131-2	Requirements per standard: EN 60721-3-3 / Class 3M4
Shock <sup>1)</sup> Operation	Acceleration 15 g Duration 11 ms 18 shocks	Acceleration 10 g Duration 11 ms 18 shocks

- 1) Pulse (half-sine) stress in all 3 axes (x, y, z), 1 octave per minute

### Vibration (sinusoidal) / Transport (packaged)

Testing performed per standard: EN 60068-2-6	Requirements per standard: EN 60721-3-2 / Class 2M1		Requirements per standard: EN 60721-3-2 / Class 2M2		Requirements per standard: EN 60721-3-2 / Class 2M3	
Vibration (sinusoidal) <sup>1)</sup> Transport (packaged)	Frequency	Amplitude	Frequency	Amplitude	Frequency	Amplitude
	2 to 9 Hz	Deflection 3.5 mm	2 to 9 Hz	Deflection 3.5 mm	2 to 8 Hz	Deflection 7.5 mm
	9 to 200 Hz	Acceleration 1 g <sup>2)</sup>	9 to 200 Hz	Acceleration 1 g <sup>2)</sup>	8 to 200 Hz	Acceleration 2 g <sup>2)</sup>
	200 to 500 Hz	Acceleration 1.5 g <sup>2)</sup>	200 to 500 Hz	Acceleration 1.5 g <sup>2)</sup>	200 to 500 Hz	Acceleration 4 g <sup>2)</sup>
20 sweeps for each axis <sup>3)</sup>						

- 1) Uninterrupted duty with movable frequency in all 3 axes (x, y, z); 1 octave per minute  
 2) 1 g = 10 m/s<sup>2</sup>  
 3) 2 sweeps = 1 frequency cycle ( $f_{min} \rightarrow f_{max} \rightarrow f_{min}$ )

### Shock / Transport (packaged)

Testing performed per standard: EN 60068-2-27	Requirements per standard: EN 60721-3-2 / Class 2M1	Requirements per standard: EN 60721-3-2 / Class 2M2
Shock <sup>1)</sup> Transport (packaged)	Type I Acceleration 10 g Duration 11 ms 18 shocks	
	Type II -	Type II Acceleration 30 g Duration 6 ms 18 shocks

- 1) Pulse (half-sine) stress in all 3 axes (x, y, z)

### Free fall / Transport (packaged)

Testing performed per standard: EN 60068-2-31 <sup>1)</sup>	Requirements per standard: EN 61131-2 with shipping packaging		Requirements per standard: EN 61131-2 with product packaging		Requirements per standard: EN 60721-3-2 / Class 2M1	
Free fall Transport (packaged)	Weight	Height	Weight	Height	Weight	Height
	<10 kg	1.0 m	<10 kg	0.3 m	<20 kg	0.25 m
	10 to 40 kg	0.5 m	10 to 40 kg	0.3 m	20 to 100 kg	0.25 m
	>40 kg	0.25 m	>40 kg	0.25 m	>100 kg	0.1 m
5 attempts						

- 1) Replacement for EN 60068-2-32

**Toppling / Transport (packaged)**

Testing performed per standard: EN 60068-2-31	Requirements per standard: EN 60721-3-2 / Class 2M1		Requirements per standard: EN 60721-3-2 / Class 2M2		Requirements per standard: EN 60721-3-2 / Class 2M3	
Toppling Transport (packaged)	Weight	Required	Weight	Required	Weight	Required
	<20 kg	Yes	<20 kg	Yes	<20 kg	Yes
	20 to 100 kg	-	20 to 100 kg	Yes	20 to 100 kg	Yes
	>100 kg	-	>100 kg	-	>100 kg	Yes
Topple on all edges		Topple on all edges		Topple on all edges		

**7.2.5 Electrical safety****Overvoltage category**

Requirement per standard: EN 61131-2	Explanation per standard: EN 60664-1
Overvoltage category II	Equipment of "Overvoltage category II" is energy-consuming equipment to be supplied by the fixed installation.

**Pollution degree**

Requirement per standard: EN 61131-2	Explanation per standard: EN 60664-1
Pollution degree 2	Only non-conductive pollution occurs. Occasionally, however, temporary conductivity caused by condensation is to be expected.

**Protection rating provided by enclosure (IP code)**

Requirement per standard: EN 61131-2	Explanation of code numbers per standard: EN 60529	Meaning for the protection of equipment	Meaning for the protection of personnel
Back: ≥IP20	First number IP2x	Protected against solid foreign bodies with a diameter ≥12.5 mm	Protected against touching dangerous parts with fingers
	Second number IPx0	Not protected.	-

Requirement per manufacturer	Explanation of code numbers per standard: EN 60529	Meaning for the protection of equipment	Meaning for the protection of personnel
Front: IP65	First number IP6x	Dust-proof.	Protected against touching dangerous parts with conductor.
	Second number IP x5	Protection against water jets.	-

**7.3 Underwriters Laboratories (UL)****UL markings**

Ind. Cont. Eq.  
E115267

**Underwriters Laboratories (UL)**

Products with this mark are tested by Underwriters Laboratories and listed as "industrial control equipment" in category NRAQ (programmable controllers) with file number E115267.

This mark is valid for the USA and Canada and simplifies the certification of your machines and manufacturing systems in this economic region.

**Canada / USA**

Standards applied:

UL 61010-1	Safety requirements for electrical equipment for measurement, control and laboratory use - Part 1: General requirements
UL 61010-2-201	Standard for safety requirements for electrical equipment for measurement, control and laboratory use - Part 2-201: Particular requirements for control equipment
CSA C22.2 No. 61010-1	Safety requirements for electrical equipment for measurement, control and laboratory use - Part 1: General requirements
CSA C22.2 No. 61010-2-201	Safety requirements for electrical equipment for measurement, control and laboratory use - Part 2-201: Particular requirements for control equipment

**Certificate**

[Website](#) > [Downloads](#) > [Certificates](#) > [UL](#) > [Power Panel](#)



**Publishing information**

B&R Industrial Automation GmbH

B&R Strasse 1

5142 Eggelsberg

Austria

Telephone: +43 7748 6586-0

Fax: +43 7748 6586-26

[office@br-automation.com](mailto:office@br-automation.com)